

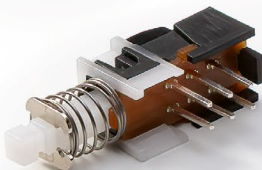

# C&K<sup>®</sup> Switch Product Selection Guide

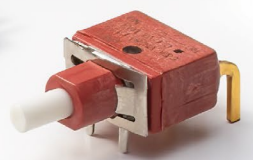

This product guide contains a selection of our most popular switch components

# A Selection from our **55K Products**

For over 80 years, leading designers, manufacturers and distributors of electronics have turned to C&K when they require mission-critical reliability in an electromechanical switch, high-rel connector or custom assembly. The reason they keep coming back is because C&K's innovative design, cutting-edge production process, and strict quality assurance standards produce the world's best switches and components.

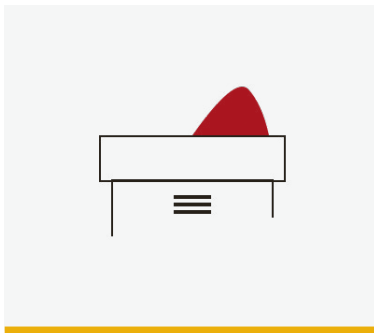

## DETECT SWITCHES

Surface mount, through-hole,  
Sealed  
Pushbutton, snap-acting, lever actuation

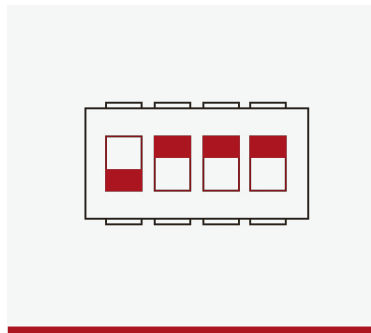

## DIP SWITCHES

1-16 position  
Surface mount, through-hole  
Washable  
Top, side actuation

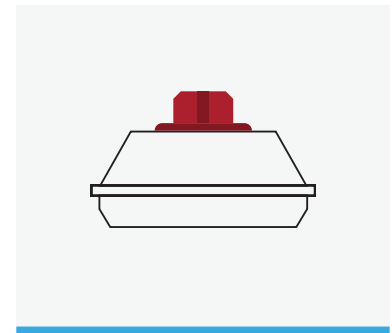

## KEYSWITCHES

Surface mount, through-hole  
Illuminated  
Momentary, push-on/push-off

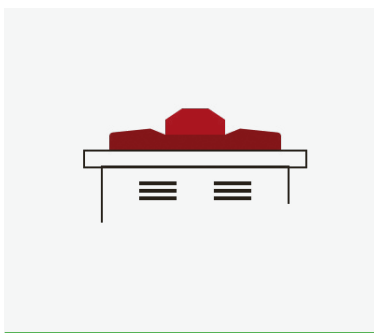

## NAVIGATION SWITCHES

Multi-direction  
Joystick, rocker

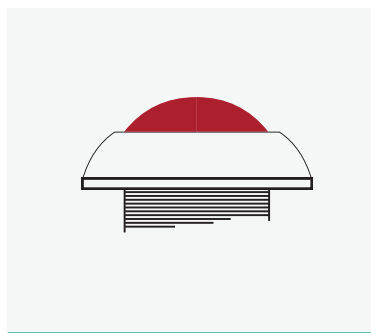

## PUSHBUTTONS

Illuminated  
Sealed  
Miniature, subminiature, microminiature  
Surface mount, through-hole, bushing mount

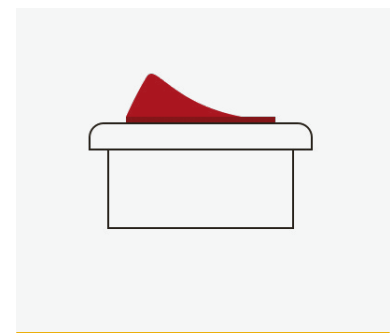

## ROCKER SWITCHES

Snap-in, panel mount  
Illuminated options  
Several body sizes and shapes

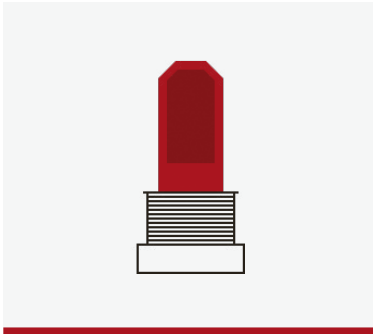

**ROTARY SWITCHES**

Multi-pole, multi-position  
Sealed

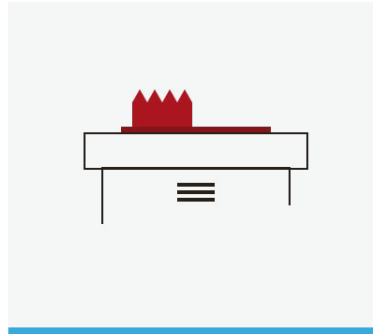

**SLIDE SWITCHES**

Miniature, ultraminiature  
Process sealed switches  
Surface mount, through-hole

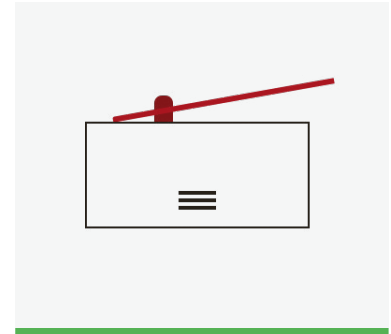

**SNAP-ACTING SWITCHES**

Miniature, subminiature  
Sealed  
Broad range of operating forces and lever styles  
Power ratings up to 30 A

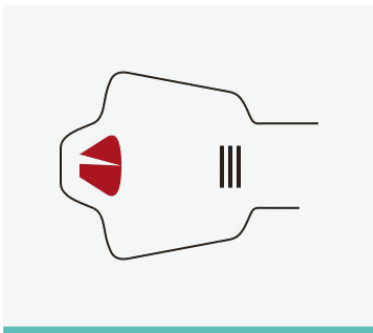

**SWITCHLOCKS**

Solder lug terminal  
PC thru-hole  
Wire lead  
Quick connect  
Anti static switch  
200 to 2,000 different key codes

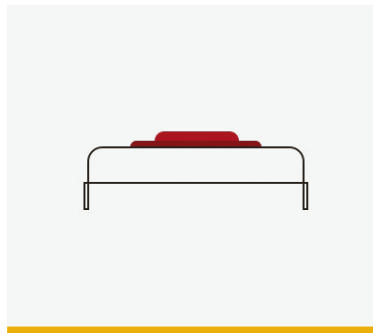

**TACTILE SWITCHES**

Surface mount, through-hole  
Sealed  
Top, side actuation  
100,000 to 1,000,000 cycles

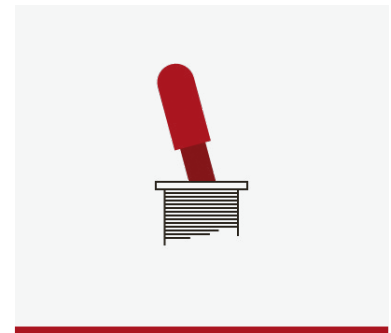

**TOGGLE SWITCHES**

Miniature, subminiature, ultraminiature  
Sealed  
Surface mount, through-hole, bushing mount

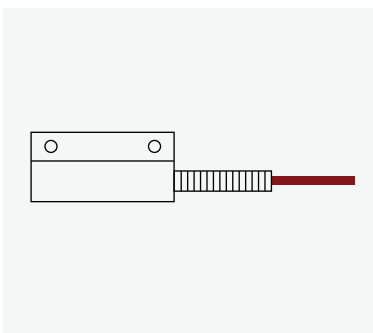

**SENSORS**

Sealed  
Long life  
Quick & easy installation

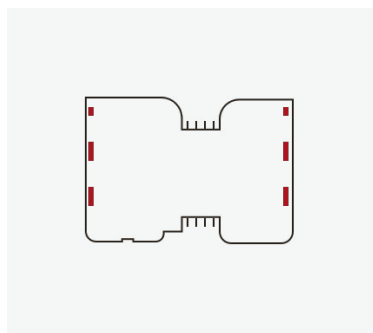

**SMARTCARD CONNECTORS**

ISO, SIM, SAM cards  
Low profile  
Anti-piracy

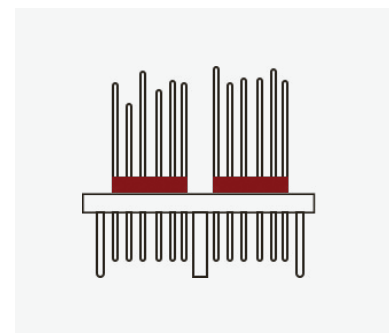

**HIGH RELIABILITY CONNECTORS**

Microminiature & D-sub  
Mil/Aero & medical  
Board-board, board-cable, cable-cable

# SWITCH

*SOLUTION DESIGN INNOVATION*

## TABLE OF CONTENT

<b>5-13</b>	Detect
<b>14-20</b>	DIP
<b>21-25</b>	Keypad
<b>26-28</b>	Navigation
<b>29-37</b>	Pushbutton
<b>38-42</b>	Rocker
<b>43-46</b>	Rotary
<b>47-54</b>	Slide
<b>55-62</b>	Snap-Acting
<b>63-65</b>	Switchlock
<b>66-85</b>	Tactile
<b>86-92</b>	Toggle
<b>93-95</b>	Sensor Products
<b>96-97</b>	Smart Card Connectors
<b>98-99</b>	High Reliability Connectors
<b>100-102</b>	Part Number Index

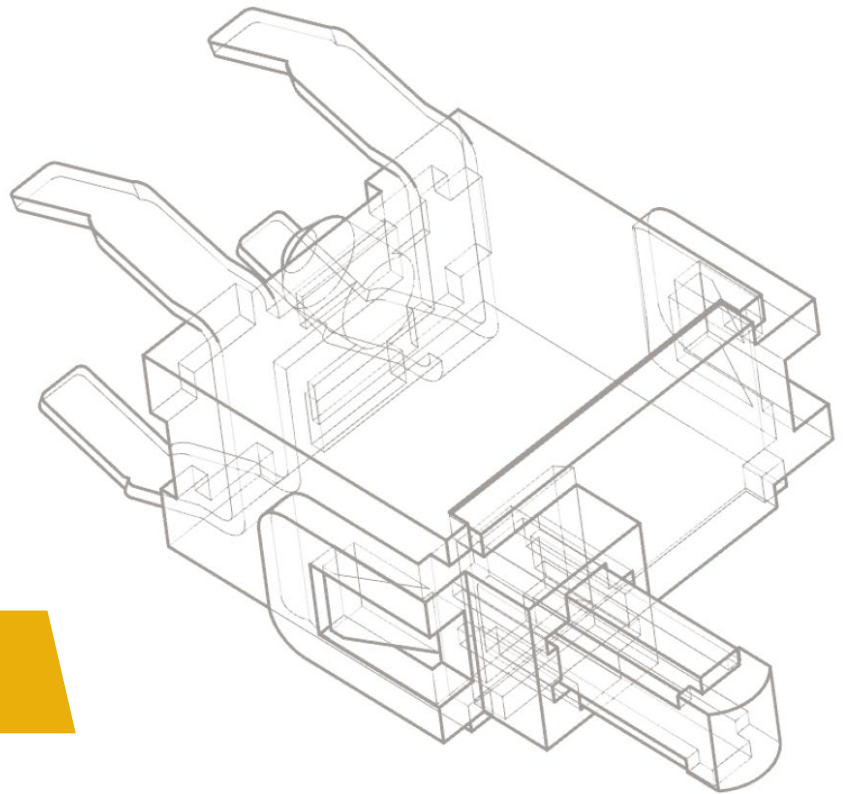

## PRODUCT SELECTION GUIDE

# Detect Switches

With different series of standard detect switches, C&K offers the largest selection in SMT, through-hole, panel and snap-in / chassis and screw-mount versions. C&K's detect switches are offered in a variety of sizes and shapes, with various actuator orientations including vertical or horizontal, top or side, or right-angle or left, and come with soft actuation force. These detect switches include low profile, compact, micro- and ultra-miniature designs, with some sealed versions available.



SERIES	HDT	DS	HDS	HDP	SDS	DDS
<b>Travel to Make (mm)</b>	0.3	See datasheet	0.17	0.24	0.35	0.45
<b>Overtravel</b>	0.75	See datasheet	0.5	1.66	1.65	1.95
<b>Total Travel</b>	1.05	See datasheet	1.07	1.9	2.0	2.4
<b>Actuator Length</b>	1.4	See datasheet	1.17	2.15	2.5	2.6
<b>Life Cycle</b>	100,000	20,000 / 50,000 / 100,000	100,000	100,000	50,000	50,000
<b>Contact Type</b>	SPST N.O.	SPST / SPDT	SPST N.O.	SPST N.O.	SPST N.O. SPST N.C.	SPST N.O.
<b>Max. Voltage</b>	5 V	5 V / 16 V / 30 V	5 V	5 V	12 V	30 V
<b>Max. Switching Current</b>	1 mA	1 mA / 5 mA / 100 mA	1 mA	1 mA	100 mA	100 mA
<b>Sealing</b>	No	No	No	No	No	No
<b>Mounting</b>	Surface mount	Thru-hole, solder lug	Surface mount	Surface mount	Surface mount	Thru-hole



SERIES	FDSD	FDSE	KDS	KSU
<b>Travel to Make (mm)</b>	1.6 (15°)	1.44	1.25 max.	0.5
<b>Overtravel</b>	1.45	1.07	8.9	1.0
<b>Total Travel</b>	3.05 (60°)	3.14 (60°)	10.16	1.5
<b>Actuator Length</b>	2.3	2.67	10.16	1.5
<b>Life Cycle</b>	50,000	50,000	10,000	100,000
<b>Contact Type</b>	SPST N.O.	SPST N.C.	SPST N.O. SPST N.C.	SPST N.O.
<b>Max. Voltage</b>	5	5	20 V	32 V
<b>Max. Switching Current</b>	10 mA	1 mA	0.4 VA	50 mA
<b>Sealing</b>	No	No	No	Dust and water drop proof
<b>Mounting</b>	Surface mount	Surface mount	Snap-in panel	Surface mount



SERIES	ATS	KSR D	KSC D	KSJ D	KMT0 D
Travel to Make (mm)	0.7 (to break)	0.3	0.6	0.5	0.15
Overtravel	0.4		0.65	0.4	
Total Travel	1.1	0.3	1.5	1.05	0.25
Actuator Length	1.6	0.8	2.6	1.4	0.35
Life Cycle	5,000	100,000	500,000 / 2,000,000	200,000	300,000
Contact Type	SPST N.C.	SPST N.O.	SPST N.O.	SPST N.O.	SPST N.O.
Max. Voltage	32 V	32 V	32 V	32 V	32 V
Max. Switching Current	50 mA	10 mA	10 mA / 50 mA	10 mA / 50 mA	25 mA
Sealing	IP54	Dust and flux tight	IP67	Flux tight	IP68
Mounting	Surface mount	Surface mount	Surface mount	Thru-hole	Surface mount



SERIES	KMR D	K12S D	K12 D	RB
Travel to Make (mm)	0.225	0.85*	0.55*	10° / 90°
Overtravel		0.65	0.95 / 1.45	
Total Travel	0.4	1.5	1.5 / 2	
Actuator Length	1.1			
Life Cycle	100,000	300,000	1,000,000	20,000 / 100,000
Contact Type	SPST N.O.	SPST N.O. / N.C. DPST N.O. / N.C.	SPST N.O. / N.C.	SPST / SPDT
Max. Voltage	32 V	30 V	32 V	5 V / 24 V
Max. Switching Current	50 mA	100 mA	100 mA	1 mA / 25 mA
Sealing	IP40	IP40 / 6x	IP 40	
Mounting	Surface mount	Surface mount	Thru-hole	Thru-hole

\* For information



**HDT SERIES**

**Micro Miniature Surface Mount Detect Switches**

**Features / Benefits**

Low profile package  
 Design allows top or side actuation  
 Low actuation force, 35 grams max.  
 Pick and place compatible, available in tape & reel packaging  
 Halogen free

**Typical Applications**

Consumer electronics  
 Computers  
 Medical devices  
 ATCA and MicroTCA devices

PART NUMBER	Contact Type	Contact Rating	Pre-Travel	Overtravel	Total Travel	Mechanical / Electrical Life
HDT0001	SPST, NO	1 mA 5 VDC	.30 mm	.75 mm	1.05 mm	100,000 cycles min.



**HDS SERIES**

**Micro Mini Side Actuated Surface Mount Detect Switches**

**Features / Benefits**

Low profile package sits just 1.4 mm off PCB  
 Design allows top or side actuation  
 Right and left options available

**Typical Applications**

Consumer electronics  
 Medical devices  
 ATCA and MicroTCA devices

PART NUMBER	Contact Type	Contact Rating	Contact Material	Total Travel	Over Travel	Operating Life
HDS001R	SPST, NO	1 mA 5 VDC	Silver over nickel	1.87 mm	1.5 mm	100,000 cycles



**HDP SERIES**

**Micro Mini Side Actuated Surface Mount Detect Switches**

**Features / Benefits**

Low profile  
 Right and left options available  
 Side actuation

**Typical Applications**

Consumer electronics  
 Medical devices  
 ATCA and MicroTCA devices

PART NUMBER	Contact Type	Contact Rating	Contact Material	Total Travel	Over Travel	Operating Life
HDP001R	SPST, NO	1 mA 5 VDC	Silver over nickel	3.2 mm	2.96 mm	100,000 cycles





**SDS SERIES**

**Micro Miniature Surface Mount Detect Switches**

**Features / Benefits**

Low profile package sits just 2mm off PCB  
 2mm overtravel ideal for detector applications  
 Low actuation force (75 grams max.)  
 RoHS compliant and compatible

**Typical Applications**

Medical devices  
 Consumer electronic devices  
 PCB lock cam detect  
 Smart card detect  
 ATCA and MicroTCA

PART NUMBER	Contact Type	Contact Rating	Contact Material	Total Travel	Over Travel	Operating Life
SDS0001	SPST, NO	100 mA @ 12 VDC	Silver	2.0 mm	1.65 mm	50,000 cycles



**FDSD SERIES**

**Micro Mini Side Actuated Detect Switches**

**Features / Benefits**

Extremely small package size  
 Vertical side actuation  
 Flat or bending terminations  
 Long travel type  
 RoHS compatible and compliant

**Typical Applications**

Consumer electronics  
 Medical devices  
 Safety control devices

PART NUMBER	Actuator Height	Operating Force	Contact Material	Electrical Life	Travel
FDSD001R	2.3 mm	40 gf	Silver	50,000 cycles	3.05 mm
FDSD002R	2.3 mm	40 gf	Silver	50,000 cycles	3.05 mm



**FDSE SERIES**

**Micro Mini Angled Actuated Detect Switches**

**Features / Benefits**

Extremely small package size  
 Angled actuation  
 Flat or bending terminations  
 Long travel type  
 RoHS compatible and compliant

**Typical Applications**

Consumer electronics  
 Medical devices  
 Safety control devices

PART NUMBER	Actuator Height	Operating Force	Contact Material	Electrical Life	Travel
FDSE001R		3.5 gf	Silver	50,000 cycles	3.14 mm
FDSE002R		3.5 gf	Silver	50,000 cycles	3.14 mm



**KSU SERIES**

**Micro Miniature Surface Mount Detect Switches**

**Features / Benefits**

- New multi contact construction
- Metal actuator
- Low actuating force
- Silver / Gold contacts
- Compatible with pick and place machines

**Typical Applications**

- Mobile phones and other handheld device
- Portable medical devices
- Audio devices
- Automotive
- Alarm devices
- Payment terminals

**PART NUMBER**

**Contact Type**

**Contact Material**

**Travel**

**Operating Force**

**Operating Life**

**KSU211WLFG**

SPST, NO

Silver

0.65 mm - 0.45/+0.25 mm

0.7 ± 0.5 N

100,000 cycles

**KSU213WLFG**

SPST, NO

Gold

0.65 mm - 0.45/+0.25 mm

0.7 ± 0.5 N

100,000 cycles



**ATS SERIES**

**Anti-Tampering Switches**

**Features / Benefits**

- Normally closed function
- Vertical detect
- Reliable long time compression
- IP54

**Typical Applications**

- Smart meters
- Alarm systems
- Anti-tamper devices

**PART NUMBER**

**Contact Type**

**Contact Material**

**Contact Rating**

**Operating Force**

**Operating Life**

**Termination**

**ATS2D1GNC LFS**

SPST-NC

Silver

50 mA @ 32 VDC

2 N

5,000 cycles

Surface mount

**ATS2D3GNC LFS**

SPST-NC

Gold

50 mA @ 32 VDC

2 N

5,000 cycles

Surface mount



**KSC D SERIES**  
**Sealed Detect Switches for SMT**

**Features / Benefits**

- Soft actuator
- Permanent actuation possible
- J bend or gull wing terminations
- Tape & reel
- IP67

**Typical Applications**

- Automotive
- Cellular phones
- Industrial electronics
- Computer infrastructure and IT

PART NUMBER	Contact Type	Contact Material	Travel	Over Travel	Operating Life
<b>KSC4D2J50SH LFS</b>	SPST, NO	Silver	0.6 ± 0.25	0.65 mm	2,000,000 cycles
<b>KSC4D3J50SH LFG</b>	SPST, NO	Gold	0.6 ± 0.25	0.65 mm	500,000 cycles
<b>KSC4D3J50SH LFG ULC *</b>	SPST, NO	Gold	0.6 ± 0.25	0.65 mm	500,000 cycles

\* ULC: Ultra low current 0.01 mA @ 1.8 V DC



**KSJ D SERIES**  
**Spherical Actuator Detect Switches**

**Features / Benefits**

- Straight or vertical detect
- Spherical actuator allows actuation +/- 30°
- High travel / silent switch
- Adapted for cam actuation

**Typical Applications**

- Automotive
- Industrial electronics
- Computer infrastructure and IT

PART NUMBER	Contact Type	Contact Material	Travel	Over Travel	Operating Life
<b>KSJ0VD1860SH LFTR</b>	SPST, NO	Silver	0.5 ± 0.25	0.4 mm	200,000 / 30,000 cycles
<b>KSJ0MD3860SH LFTR</b>	SPST, NO	Gold	0.5 ± 0.25	0.4 mm	200,000 / 30,000 cycles

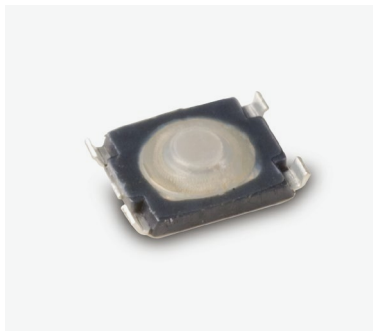

**KMT0 D SERIES**  
**Momentary Detect Switches**

**Features / Benefits**

Smallest footprint  
Smallest thickness with integrated actuator  
IP68

**Typical Applications**

Hearing aids  
Medical devices (glucose meter)  
IoT  
Bluetooth headset  
Consumer electronics

**PART NUMBER**

**KMT0D1 NGJ LHS**

**KMT0D3 NGJ LHG**

**Contact Type**

SPST, NO

SPST, NO

**Contact Material**

Silver

Gold

**Travel**

0.15 ± 0.1

0.15 ± 0.1

**Electrical Life**

300,000 cycles

300,000 cycles



**KMR D SERIES**  
**Momentary Detect Switches**

**Features / Benefits**

Ground pin  
Height 2.5 mm  
Compact size 4.6 x 2.8

**Typical Applications**

IoT  
Bluetooth headset  
Consumer electronics

**PART NUMBER**

**KMR401G LFS**

**Contact Type**

SPST, NO

**Contact Material**

Silver

**Travel**

0.225 ± 0.175

**Electrical Life**

100,000 cycles



**K12S D SERIES**  
**Detect Switches**

**Features / Benefits**

Harsh environment applications  
Illuminated  
SPST / DPST configurations  
Designed for low-level switching  
NC versions available  
Permanent actuation possible

**Typical Applications**

Motorbike / Automotive  
Industrial electronics  
Medical equipment

**PART NUMBER**

**K12SA S 1.5 3N O LFTX**

**K12SA S 1.5 3N C LFTX**

**K12SB D 1.5 3N OO LFTX**

**K12SB D 1.5 3N CC LFTX**

**Contact Type**

SPST, NO

SPST, NC

DPST, NO

DPST, NC

**Contact Material**

Gold

Gold

Gold

Gold

**Electrical Height**

8.2 ± 0.2

8.2 ± 0.2

8.2 ± 0.2

8.2 ± 0.2

**Over Travel**

0.4

0.4

0.4

0.4

**Electrical Life**

300,000 cycles

300,000 cycles

300,000 cycles

300,000 cycles



**K12 D SERIES**  
**Detect Switches**

**Features / Benefits**

Overtravel up to 1.6 mm  
Permanent actuation possible  
Designed for low-level switching

**Typical Applications**

Industrial electronics  
Medical equipment  
Off-road transportation

PART NUMBER	Contact Type	Contact Material	Electrical Height	Over Travel	Electrical Life
<b>K12P BK 1.5 1.5 OD</b>	SPST, NO	Gold	10.45 ± 0.2	1.1	1,000,000 cycles
<b>K12P BK 2 1.5 OD</b>	SPST, NO	Gold	10.45 ± 0.2	1.6	1,000,000 cycles



**RB SERIES**  
**Rolling Ball Sensor Switches**

**Features / Benefits**

Compact shielded design  
10 degree angle of detection  
Conductive ball is movable inside tube to generate signal and control

**Typical Applications**

Movement detection  
White goods  
Consumer electronics

PART NUMBER	Contact Type	Contact Rating	Sensor Angle	Operating Life	Termination
<b>RB-231X2</b>	SPST	1 mA 5 V DC resistive load max	0° to 10° scope	100,000 cycles	PC thru-hole
<b>RB-441-45</b>	SPDT	25 mA 24 V DC resistive load max	45° ± 15°	100,000 cycles	PC thru-hole

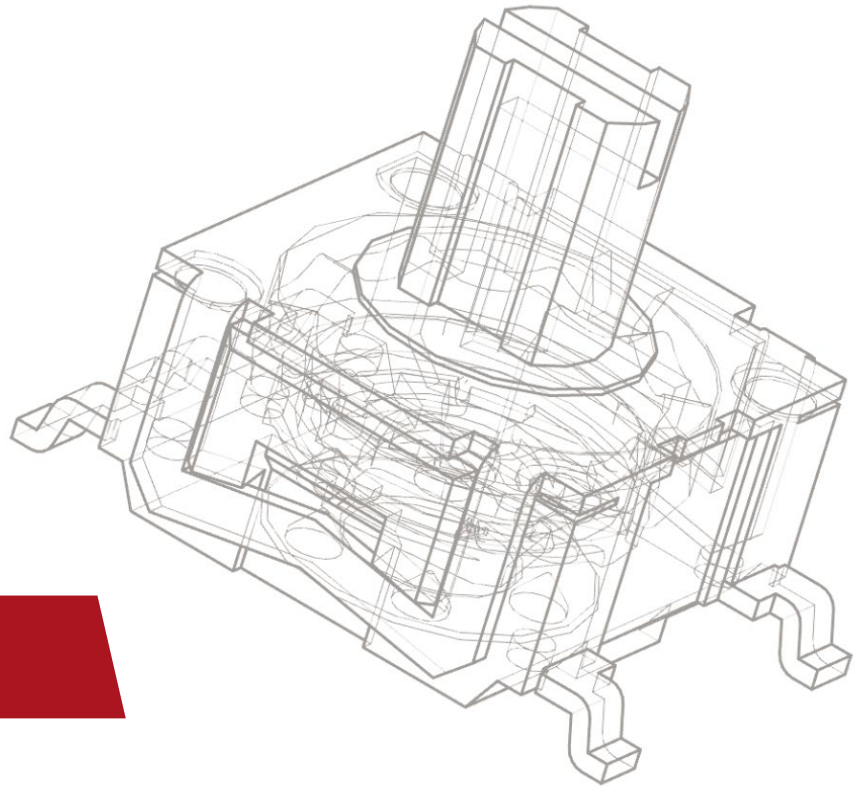
**PRODUCT SELECTION GUIDE**

# DIP Switches

C&K's series of surface mount half-pitch DIP switches, low profile and standard profile DIP switches, rotary and coded DIP switches, coded rotary DIP switches, SIP switches and jumper switches feature a variety of extended actuator and flush actuator styles. C&K DIP switches are available in surface mount, through-hole, right angle and vertical mounting options.



SERIES	TDP	TDA	SDA	SD	BD
<b>Switch Type</b>	Half-pitch .050" side	Half-pitch .050"	Low profile	Low profile	Standard profile
<b>No. of Positions</b>	2, 4, 8	2-10 (even only)	2-12 (except 11)	2-12 (except 11)	1-12 (except 11)
<b>Contact Style</b>	SPST	SPST	SPST	SPST	SPST
<b>Profile Off PCB</b>	.161 (4.1)	.090 (2.3)	.189 (4.80) thru-hole .175 (4.45) SMT	.168 (4.27) thru-hole .160 (4.06) SMT	.297 (7.55)
<b>Process Sealed</b>	Washable with tape	Washable with tape seal	Washable (tape not required)	Washable with tape	Washable (tape not required)
<b>Extended Actuator</b>	•		•	•	•
<b>Flush Actuator</b>	•	•	•	•	
<b>Thru-hole</b>			•	•	•
<b>Vertical</b>		•	•	•	•
<b>Right Angle</b>	•				•
<b>Surface Mount</b>	•	•	•	•	
<b>Tape &amp; Reel (SMT only)</b>		•	•	•	
<b>Maximum Current</b>	100 mA	100 mA	100 mA	100 mA	100 mA



SERIES	BPA	TDD	SPA	RTE
<b>Switch Type</b>	Side actuated	Jumper switch	Single in-line package	Rotary & coded
<b>No. of Positions</b>	1-10 & 12	2	2, 4, 6, 8, 10	4, 10, 16
<b>Contact Style</b>	SPST	SPDT	SPST / SP3T / SP4T / coded	Coded
<b>Profile Off PCB</b>	.287 (7.3) thru-hole .274 (6.96) SMT	.090 (2.3)	.244 (6.2) vertical .169 (4.3)	.169 (4.25) thru-hole .168 (4.27) SMT
<b>Process Sealed</b>	Washable (tape not required)	Washable with tape	Washable (tape not required)	
<b>Extended Actuator</b>	•		•	•
<b>Flush Actuator</b>		•	•	•
<b>Thru-hole</b>	•		•	•
<b>Vertical</b>		•	•	•
<b>Right Angle</b>	•		•	•
<b>Surface Mount</b>	•	•	•	•
<b>Tape &amp; Reel (SMT only)</b>	•	•	•	•
<b>Maximum Current</b>	100 mA	100 mA	0.4 VA	100 mA
<b>Retention Feature</b>			•	•



**SERIES**

**Switch Type**

**No. of Positions**

**Contact Style**

**Profile Off PCB**

**Process Sealed**

**Extended Actuator**

**Flush Actuator**

**Thru-hole**

**Vertical**

**Right Angle**

**Surface Mount**

**Tape & Reel (SMT only)**

**Maximum Current**

**Retention Feature**

**CD**

8 mm coded rotary

8, 10, 16

Coded

.168 (4.27) thru-hole  
.340 (8.6) Rt. angle

Washable (tape not required)

•

•

•

•

•

•

•

0.4 VA

• C option

**CRD**

10 mm coded rotary

10 & 16

Coded

.256 (6.5) vertical  
.414 (10.5) Rt. angle

Washable (tape not required)

•

•

•

•

•

•

•

0.4 VA

**RTF**

DIP

4, 10, 16

Coded

Varies

•

•

•

•

•

•

•

100 mA

**CRE**

10 mm coded rotary

4, 6, 8, 10, 16

Coded

0.331" (8.4 mm) Flush /  
0.370" (9.4 mm) Protrusion /  
0.618" (15.7 mm) Extended

Washable (tape not required)

•

•

•

•

•

•

•

150 mA



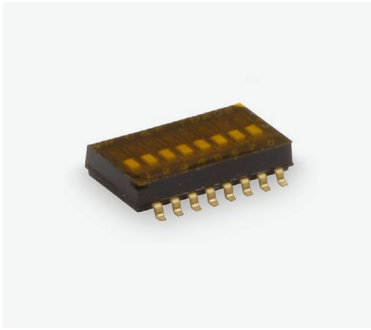

**TDA SERIES**  
**Ultra-miniature Surface Mount Half-pitch DIP Switches**

**Features / Benefits**

Bifurcated contact for increased electrical reliability  
 Process sealed for surface mount soldering and washable processing

**Contact Rating:**

24 V DC, 25 mA (switching)  
 50 V DC, 100 mA (steady state)

**Typical Applications**

Hand-held electronic devices  
 Portable computer and electronic devices  
 Instrumentation and controls

PART NUMBER	Number of Positions	Actuator	Mounting Style / Termination	Contact Material	Electrical Life
TDA04H0SB1R	SPST, 4 pos.	Flush actuator	SMT, gull wing	Gold	1,000 cycles
TDA08H0SB1R	SPST, 8 pos.	Flush actuator	SMT, gull wing	Gold	1,000 cycles
TDA10H0SB1R	SPST, 10 pos.	Flush actuator	SMT, gull wing	Gold	1,000 cycles



**SDA SERIES**  
**Low Profile DIP Switches**

**Features / Benefits**

Low profile design saves space  
 Thru-hole and surface mount models  
 High pressure contact does not require tape seal for washing

**Contact Rating:**

25 mA @ 24 V DC or 100 mA @ 5 V DC

**Typical Applications**

Address switch for industrial controls  
 Logic switching for computers and peripherals  
 Function controlling for numerous applications

PART NUMBER	Number of Positions	Actuator	Mounting Style / Termination	Contact Material	Electrical Life
SDA08H0B	SPST, 8 pos.	Flush actuator – with top tape	PC thru-hole	Gold plating	1,000 cycles
SDA03H0SBR	SPST, 3 pos.	Flush actuator – with top tape	SMT, gull wing	Gold plating	1,000 cycles
SDA04H0SBR	SPST, 4 pos.	Flush actuator – with top tape	SMT, gull wing	Gold plating	1,000 cycles



**BPA SERIES**  
**Side Actuated DIP Switches**

**Features / Benefits**

Side actuated contacts  
Available in thru-hole or SMT models  
High pressure contact system does not require tape seal for washing

**Contact Rating:**

100 mA max. @ 5 V DC or 25 mA max. @ 24 V DC

**Typical Applications**

Address switch for industrial controls  
Logic switching for computers and peripherals  
Function controlling for numerous applications

PART NUMBER	Number of Positions	Actuator	Mounting Style / Termination	Contact Material	Electrical Life
BPA04B	SPST, 4 pos.	Side actuator / Piano	PC thru-hole	Gold over nickel plate	1,000 cycles
BPA01B	SPST, 1 pos.	Side actuator / Piano	PC thru-hole	Gold over nickel plate	1,000 cycles
BPA05SB	SPST, 5 pos.	Side actuator / Piano	SMT, gull wing	Gold over nickel plate	1,000 cycles

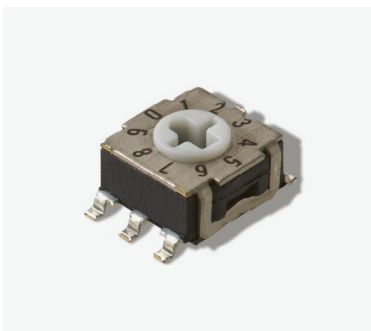

**RTE SERIES**  
**Low Profile Rotary DIP Switches**

**Features / Benefits**

Miniature size with robust stainless steel cover  
Rotary SPDT, SP3T, SP4T functions  
Rotary binary-decimal and hexadecimal coding

**Contact Rating:**

Gold: 100 mA max. 10  $\mu$ A min. 30 V DC max. 20 mVDC min.  
Silver: 100 mA max. 1 mA min. 50 V DC max. 2 VDC min.

**Typical Applications**

Timers, automation components  
Computer and peripherals  
Alarms, smoke detectors, access control  
Instrumentation  
Address switching applications

PART NUMBER	Switch Function	ESD Protection / Actuator	Mounting Style / Termination	Contact Material	Electrical Life
RTE1002G14	10 position, BCD	Without ESD, shaft for button	SMT, gull wing	Gold	20,000 cycles
RTE1600V44	16 position, hexadecimal	Without ESD, flush, screwdriver slot	Right angle	Gold	20,000 cycles
RTE0400N04	4 position, single pole	Without ESD, flush, screwdriver slot	PC thru-hole	Gold	20,000 cycles



**CD / CRD SERIES**  
**8 mm / 10 mm DIP Coded Rotary Switches**

**Features / Benefits**

Process sealed – withstands soldering and cleaning  
 Thru-hole and surface mount models  
 Crisp, positive detent ensures actuation

**Contact Rating:**

0.4 VA max. @ 20 V AC or V DC max.

**Typical Applications**

Address switching applications  
 Data storage devices  
 Computer and peripherals  
 Instrumentation

PART NUMBER	Switch Function	Actuator	Mounting Style / Termination	Contact Material	Electrical Life
CD10RM0SBR	10 position, BCD	Flush, screwdriver slot	SMT, gull wing	Gold	20,000 cycles
CD16RM0SBR	16 position, hexadecimal	Flush, screwdriver slot	SMT, gull wing	Gold	20,000 cycles
CRD10RM0CB	10 position, BCD	Flush, screwdriver slot	PC thru-hole	Gold	20,000 cycles
CRD16CM0SBR	16 position, hexadecimal complement	Flush, screwdriver slot	SMT, gull wing	Gold	20,000 cycles



**RTF SERIES**  
**7.2 x 7.2 mm Low Profile Rotary DIP Switches**

**Features / Benefits**

Most compact rotary DIP switch  
 Thru-hole, crimped, J-bend, angled & surface mount models  
 New designs with different actuators  
 IP67

**Typical Applications**

Instrumentation  
 Security devices  
 Computer & peripherals  
 Industrial & control automation

PART NUMBER	Switch Function	Actuator	Mounting Style / Termination	Contact Material	Electrical Life
RTF16R0S	16 position, hexadecimal	Flush, screwdriver slot	SMT	Gold plated	10,000 cycles
RTF16R0C	16 position, hexadecimal	Flush, screwdriver slot	Thru-hole	Gold plated	10,000 cycles



**CRE SERIES**  
**10 mm DIP Coded Rotary DIP Switches**

**Features / Benefits**

New designs with different actuators  
 Process sealed - withstands soldering & cleaning  
 Thru-hole & surface mount models  
 IP65

**Typical Applications**

Address switching applications  
 Data storage devices  
 Instrumentation

<b>PART NUMBER</b>	<b>Switch Function</b>	<b>Actuator</b>	<b>Mounting Style / Termination</b>	<b>Contact Material</b>	<b>Electrical Life</b>
<b>CRE16RRDM0S</b>	16 position, hexadecimal	Flush, screwdriver slot	SMT	Gold plated	10,000 cycles
<b>CRE16RRDL0C</b>	16 position, hexadecimal	Extended, screwdriver slot	Thru-hole	Gold plated	10,000 cycles

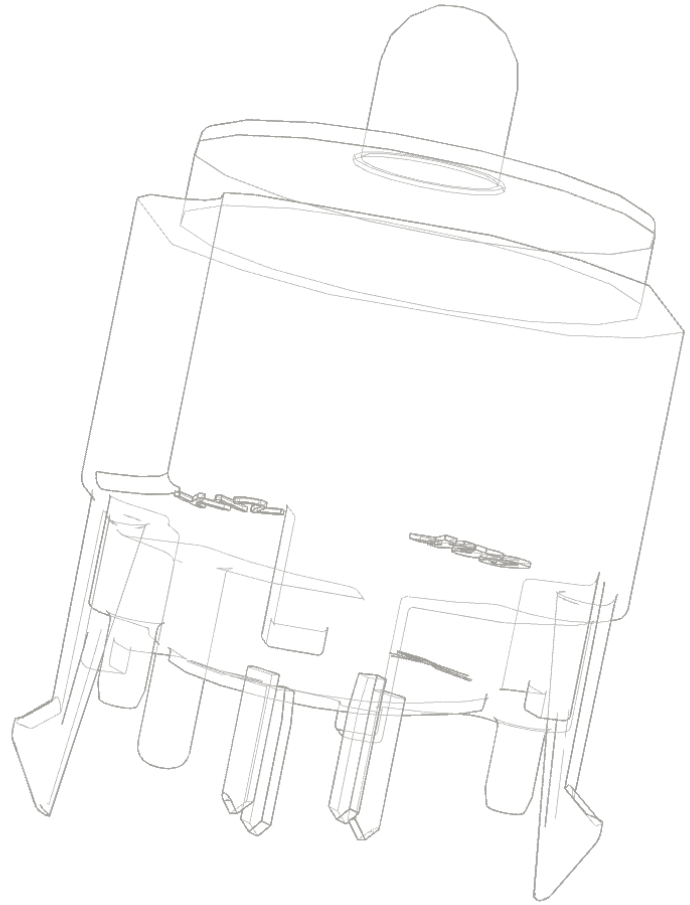

## PRODUCT SELECTION GUIDE

# Keyswitches

C&K keyswitches are designed to support high-performance, environmentally demanding applications. They are available in a large number of combined versions:

- SMT or THT solder process compatible
- IP40 or IP67 sealing level
- LED illumination option
- SPST, SPDT, DPST or DPDT electrical functions
- Normally Open or Normally Closed contacts
- Double step actuation
- Momentary or latching “push-on/push-off” versions
- Tactile or non-tactile feedback



**SERIES**

**Size (mm)  
L x W x H**

**Poles / Throws**

**Maximum Load**

**Operating Force**

**Travel (standard)**

**Life Cycle**

**IP Rating**

**Illumination**

**Termination**

**K12S**

12 x 11.6 x 9.1

SPST / DPST /  
2 x SPST momentary

30 V / 100 mA

3 N / 3.5 N / 5 N / 6 N / 9 N /  
4/8 N / 6/12 N

1.5 mm

1,000,000

IP40 / IP67

•

SMT

**K12**

12 x 12 x 11

SPST /  
2 x SPST momentary

30 V / 100 mA

1.5 N / 2.5 N / 3.5 N / 5 N /  
3.5/7 N / 6/12 N

1 mm / 1.5 mm / 2 mm

1,000,000

IP40

•

Thru-hole

**K12C**

12 x 12 x 11

SPST

30 V / 100 mA

2.5 N / 5 N / 9 N

1 mm / 1.3 mm

100,000

IP67

•

Thru-hole

**D6**

12 x 11.4 x 14.5

SPST momentary

32 V / 100 mA\*

1.3 N / 2.75 N

1 mm / 1.10 mm

250,000

•

Thru-hole



**SERIES**

**Size (mm)  
L x W x H**

**Poles / Throws**

**Maximum Load**

**Operating Force**

**Travel (standard)**

**Life Cycle**

**IP Rating**

**Illumination**

**Termination**

**KS**

12.4 x 12.4 x 9.9

SPST / SPDT

50 V / 25 mA

1.5 N

0.75 mm

100,000

IP40

•

Thru-hole

**DIGITAST**

17.1 x 12.3 x 14.3

SPDT momentary or push-on /  
push off

24 V / 10 mA

1.5 N

3 mm

5,000,000

•

Thru-hole

**ED/EDM**

12.7 x 11.3 x 1.2

SPST momentary

100 V / 100 mA

2.4 N to 6.5 N

0.3 mm

1,000,000

IP67

•

Thru-hole / SMT



### K12S SERIES High Performance SMT Key Switches

#### Features / Benefits

IP67  
 Compatible with SMT lead free soldering process / tape & reel packaging  
 Illuminated  
 Excellent tactile feel  
 High reliability / long life  
 DPST, double step and detect versions available  
 Normally closed version available

#### Typical Applications

Automotive, motorbikes  
 Off-road transportation  
 Industrial electronics  
 Medical  
 Network

PART NUMBER	Sub-Series	Type	LED Color	Travel	Operating Force	Contact Arrangement
<b>K12SB S 1.5 9N O LFTX</b>	IP67 with peg	SPST	None	1.5 mm	9 N	NO
<b>K12SB S 1.5 3.5N C LFTX</b>	IP67 with peg	SPST	None	1.5 mm	3.5 N	NC
<b>K12SC L 1.5 WHO 9N O LFTX</b>	IP40 without peg	SPST	White	1.5 mm	9 N	NO
<b>K12SC D 1.5 4/8N OO LFTX</b>	IP40 without peg	DPST	None	1.5 mm	4 / 8 N	2 NO
<b>K12SB D 1.5 12N OO LFTX</b>	IP67 with peg	DPST	None	1.5 mm	12 N	2 NO



### K12 SERIES High Performance Key Switches

#### Features / Benefits

Excellent tactile feel  
 Wide choice of LED colors, travel and actuator forces  
 Sealed version available  
 Designed for low-level switching  
 Double stroke versions available

#### Typical Applications

Automotive  
 Off-road transportation  
 Industrial electronics  
 Computers & network equipment

PART NUMBER	Function	Button Type / Color	Travel	Operating Force
<b>K12GO BK 1.5 6/12N</b>	Two-step switch	Black cap	1.5 mm	6 / 12 N
<b>K12P BK 1 5N</b>	With snap-in pegs	Black cap	1 mm	5 N
<b>K12A BK 1 5N</b>	No snap-in pegs	Black cap	1 mm	5 N
<b>K12PL WH 1.5 5N LV302</b>	With central LED	White LED	1.5 mm	5 N
<b>K12PL GN 1.5 5N LV306</b>	With central LED	Green LED	1.5 mm	5 N



**K12C SERIES**  
High Performance Key Switches

**Features / Benefits**

Excellent tactile effect  
Harsh environment applications  
IP67  
Designed for low-level switching

**Typical Applications**

Off-road transportation  
Industrial electronics  
Medical equipment  
Automotive

**PART NUMBER**

**K12C 1 5N**

**K12C 1.3 9N 0.5**

**Function**

Sealed contact with rubber cap (IP67)

Sealed contact with rubber cap (IP67)

**Button Type / Color**

Black rubber cap

Black rubber cap

**Travel**

1 mm

1.3 mm

**Operating Force**

5 N

9 N



**D6 SERIES**  
SPST Momentary Key Switches

**Features / Benefits**

Positive tactile feedback  
High temperature  
Wide variety of colors and styles

**Typical Applications**

Video  
Electronic games  
Appliances

**PART NUMBER**

**D6R90 F1 LFS**

**D6C90 F1 LFS**

**D6R10 F1 LFS**

**D6L90 F1 LFS**

**D6RLRD F1 LFS**

**D6RLWH F1 LFS**

**Function**

SPST, NO

SPST, NO

SPST, NO

SPST, NO

SPST, NO

SPST, NO

**Button Type / Color**

Round / Black

Square / Black

Round / Gray

Plunger / Black

Round / Transparent

Round / Transparent

**Travel**

0.6 mm

0.6 mm

0.6 mm

0.6 mm

0.6 mm

0.6 mm

**Operating Force**

1.3 N

1.3 N

1.3 N

1.3 N

1.3 N

1.3 N

**Illumination**

Red

White





**KS SERIES**  
**Single Pole Key Switches**

**Features / Benefits**

Positive tactile feel  
Variety of cap colors  
SPST and SPDT configurations  
RoHS compliant

**Typical Applications**

Telecommunications  
Industrial  
Instrumentation

PART NUMBER	Function	Button Type / Color	Contact Material	Seal
<b>KS11 R2 2 C Q D</b>	SPST Off-Mom.	Black cap	Silver	No epoxy
<b>KS12 R2 3 C B E</b>	SPDT On-Mom.	Red cap	Gold	Epoxy
<b>KS12 R2 1 C B D</b>	SPDT On-Mom.	White cap	Gold	No epoxy



**DIGITAST SERIES**  
**SPDT Key Switches**

**Features / Benefits**

Designed for low level switching  
High reliability / long life  
Several button options

**Typical Applications**

Medical  
Instrumentation  
Industrial electronics

PART NUMBER	Function	Button	Button Color	Contact Material	Termination
<b>SER BK AU OA</b>	SPDT, momentary	Narrow button	Black	Gold	PC thru-hole
<b>SET BK AU OA</b>	SPDT, momentary	Wide button	Black	Gold	PC thru-hole
<b>SERU AU OA</b>	SPDT, momentary			Gold	PC thru-hole
<b>SRK GY</b>		Narrow button	Gray		
<b>STK WH</b>		Wide button	White		

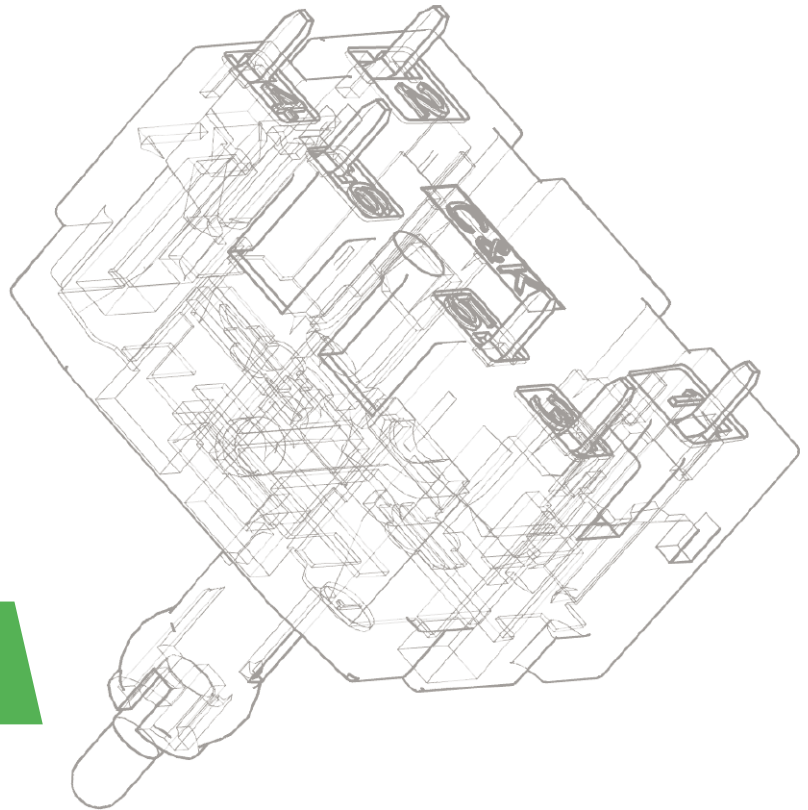
**PRODUCT SELECTION GUIDE**

# Navigation Switches

C&K's navigation switches are miniature, compact and multi-directional products. The CS series features a 4-way adjustable direction switch designed for mirror control. The THB series dual action 360° joystick is ideal for gaming, drone, and other controllers.



**SERIES**

**Number of Directions**

**CS**

4

**SAM**

2 or 4

**THB**

Dual axis with center select switch

**Size on PCB (mm)  
L x W x H**

40 x 40 x 38

20.7 x 18.0  
26.2 x 26.2

21.0 x 17.0

**Total Height (mm)**

58

27.85 or 31.85 or 27.6

19.45

**Actuation  
Force (N)**

4.9 N

5.3 / 6 N

714 ± 204 gf

**Contact Type**

Silver

Silver

SPST N.O.

**Max. Voltage (V)**

10

14

5 V DC, 50 V AC

**Max. Switching  
Power (VA)**

.02

15

0.05 A @ 12 VDC

**Life Cycles per Direction**

10,000

30,000

2,000,000

**Sealing**

Not sealed

Not sealed

Not sealed



**CS SERIES**  
4-Way Adjustable Direction Switches

**Features / Benefits**

Designed for mirror control  
Wire harness and connector easy to customize  
Easy installation  
4-way adjustable directions

**Typical Applications**

Automotive  
Industrial

PART NUMBER	Circuit	Mounting Type	Actuation Force	Current Rating	Life Cycle
CS41001E	SP4T	Panel mount, front, snap-in	200 ±100 gf / 400 ± 200 gf / 500 ± 200 gf	0.2 A @ 12 VDC	10,000 cycles



**SAM SERIES**  
Multiway Switches

**Features / Benefits**

Multi-directional switches 2-way & 4-way  
Actuation force 5.3 N or 6 N  
Footprint 20.7 x 18.0 mm (2-way) & 26.2 x 26.2 mm (4-way)

**Typical Applications**

Automotive  
Industrial

PART NUMBER	Circuit	Actuation Force	Life Cycle*	Travel (mm)
SAM-H2-LR10SPA	SPDT	6.0 ± 2.0	30,000 cycles	1.00 ± 0.4
SAM-H2-LR14SPA	SPDT	5.3 ± 2.0	30,000 cycles	1.25 ± 0.4
SAM-H2-MR14SPA	SPDT	5.3 ± 2.0	30,000 cycles	1.25 ± 0.4
SAM-H4-MR11SPA	SPDT	6.0 ± 2.0	30,000 cycles	1.00 ± 0.4

\* Life cycle per direction



**THB SERIES**  
Thumbstick

**Features / Benefits**

Higher actuation force  
Reduced "Dead Zone" slack & wide angular sweep  
Small form factor

**Typical Applications**

Industrial  
High-end consumer

PART NUMBER	Circuit	Mounting Type	Actuation Force	Current Rating	Life Cycle
THB001P	Dual Potentiometer + SPST N.O.	Thru-hole	714 ± 204 gf	0.05 A @ 12 VDC	2,000,000 cycles for toggle

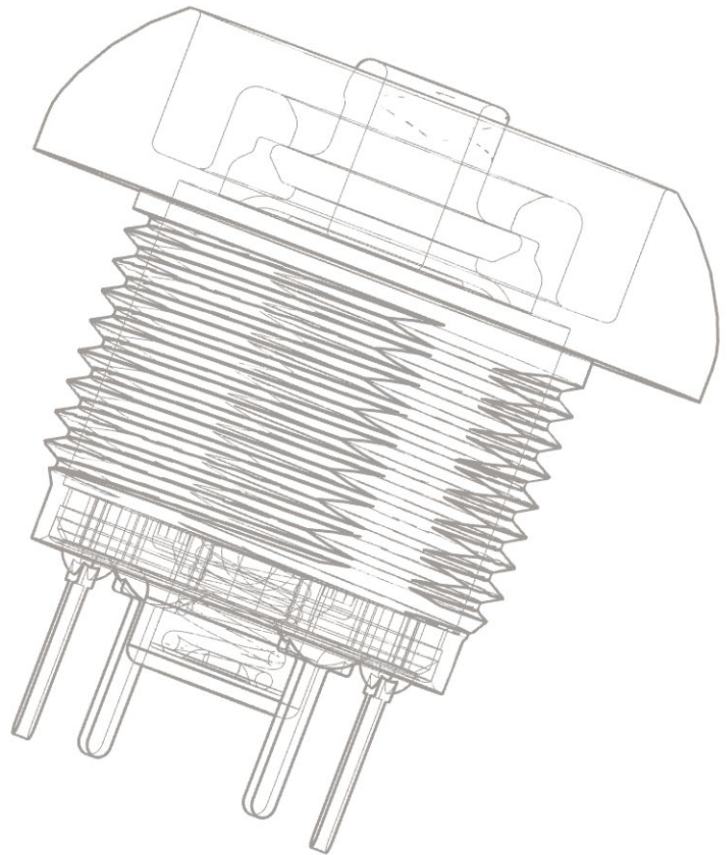

## PRODUCT SELECTION GUIDE

# Pushbutton Switches

C&K's extensive range of miniature, sub-miniature and ultra-miniature pushbuttons for printed circuit board with through-hole or surface mounted and panel application with either threaded or snap-in option. Products are offering with momentary and latch function for SPST, SPDT, DPST or DPDT circuitry in sealed and low-profile configurations. C&K pushbuttons are available in the widest selection of actuator styles, shapes and colours, with or without illumination.



SERIES	ELUM	EP	TP	E020	8020	E010	8060	8500
<b>Switch Type</b>	PCB Illuminated	Sub-miniature	Sub-miniature	Miniature	Miniature	Miniature	Sub-miniature	Sub-miniature
<b>Poles / Throws</b>	SPDT	SPST / SPDT / DPST	SPST / SPDT / DPST	SPDT / DPST	SPDT / DPDT / 3PDT / 4PDT	SPDT	SPDT / DPDT	SPST
<b>Max. Current</b>	3.5 VA	1 Amp	1 Amp	1 Amp	1 Amp	4 Amps	6 Amps	3 Amps
<b>Process Sealed</b>		•		•		•		
<b>Illuminated</b>	•				•		•	•
Mounting Options								
<b>Thru-hole</b>	•	•	•	•	•	•	•	•
<b>Surface Mount</b>	•	•						
<b>Panel Mount</b>			•		•	•	•	•

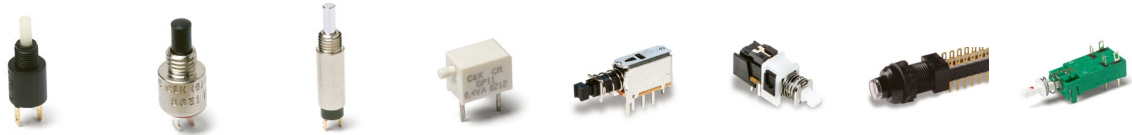

SERIES	KM	8600	8700	GP	PN	PHB	F	NE-18
<b>Switch Type</b>	Sub-miniature	Micro / Ultra-miniature	Sub-miniature	Micro / Ultra-miniature	Sub-miniature	Miniature	Miniature	Miniature
<b>Poles / Throws</b>	SPST / SPDT	SPST	SPST	SPST / SPDT	SPDT / DPDT / 4PDT	DPDT / 4PDT	DPDT / 4PDT / 6PDT / 8PDT / 10PDT	DPST / DPDT / Varied
<b>Max. Current</b>	1 Amp	500 mA	1 Amp	0.4 VA	200 mA	100 mA	500 mA	6 A
<b>Process Sealed</b>				•				
Mounting Options								
<b>Thru-hole</b>	•	•	•	•	•	•	•	•
<b>Surface Mount</b>				•				
<b>Panel Mount</b>	•	•	•				•	•



SERIES	FP	PVA	PS	PBA	AP	APB	NP	PNP
<b>Switch Type</b>	Micro / Ultra-miniature	Sub-miniature	Miniature	PCB Illuminated	Sealed / Industrial	Sealed / Industrial	Sealed / Industrial	Sealed / Industrial
<b>Poles / Throws</b>	SPST	DPST / DPDT	SPDT / DPDT	DPST	SPST	SPST	SPDT	SPST N.O. / SPST N.C. / SPDT
<b>Max. Current</b>	0.4 VA	100 mA	0.1 A / 1 A 0.3 A / 2 A	250 mA	400 mA	400 mA	5 Amp	10 mA / 3 A / 5 A
<b>Process Sealed</b>	•	IP40			IP67	IP67	IP68	IP68
Mounting Options								
<b>Thru-hole</b>	•	•	•	•	•	•	•	•
<b>Surface Mount</b>			•					
<b>Panel Mount</b>				•	•	•	•	•



SERIES	ATP	PLP16	KLS
<b>Switch Type</b>	Panel Illuminated	Panel Illuminated	PCB Illuminated
<b>Poles / Throws</b>	SPST / SPDT / DPDT	Pilot light, SPST, DPDT	SPST, DPDT
<b>Max. Current</b>	3 A / 2 A	3 A / 250 Vac 1 A / 30 Vdc	0.5 A / 25 Vdc 0.1 A / 28 Vdc
<b>Process Sealed</b>	IP67		•
Mounting Options			
<b>Thru-hole</b>	•		•
<b>Surface Mount</b>			
<b>Panel Mount</b>		•	

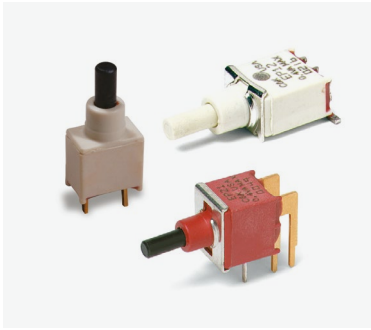

**EP SERIES**  
**Sealed Tiny Pushbutton Switches**

**Features / Benefits**

Sealed against solder & cleaning processes  
Snap-fitting actuator accepts standard caps  
Contact rating 0.4 VA max @ 20 V AC or DC max.

**Typical Applications**

Telecommunications and networking equipment  
Computers and peripherals  
Instrumentation and controls

PART NUMBER	Function	Mounting Style / Termination	Plunger	Contact Material	Operating Life
EP11SD1ABE	SPST Off-Mom.	Right angle, PC thru-hole	.215" high	Gold	60,000 cycles
EP11SD1AVBE	SPST Off-Mom.	Vertical right angle, PC thru-hole	.215" high	Gold	60,000 cycles
EP11SD1CBE	SPST Off-Mom.	PC thru-hole	.215" high	Gold	60,000 cycles
EP11SD1SAPE	SPST Off-Mom.	Right angle, surface mount	.215" high	Gold, matte-tin	60,000 cycles
EP12SD1ABE	SPDT On-Mom.	Right angle, PC thru-hole	.215" high	Gold	30,000 cycles



**TP SERIES**  
**Sealed Tiny Pushbutton Switches**

**Features / Benefits**

Subminiature size—capable of switching 1 AMP  
Epoxy terminal seal compatible with bottom wash cleaning

**Contact Rating:**

Gold: 0.4 VA max. @ 20 V AC or DC max.  
Silver: 1 AMP @ 120 V AC or 28 V DC

**Typical Applications**

Telecommunications and networking equipment  
Computers and peripherals  
Instrumentation and controls

PART NUMBER	Function	Actuator or Bushing	Mounting Style / Termination	Contact Material	Operating Life
TP11SH8ABE	SPST Off-Mom.	.155" high plunger, unthreaded; .220" high bushing, round	Right angle, PC thru-hole	Gold	60,000 cycles
TP11SH9ABE	SPST Off-Mom.	.155" high plunger, unthreaded; .220" high bushing, flat	Right angle, PC thru-hole	Gold	60,000 cycles
TP11SH9CBE	SPST Off-Mom.	.155" high plunger, unthreaded; .220" high bushing, flat	PC thru-hole	Gold	60,000 cycles
TP11SHZQE	SPST Off-Mom.	.155" high plunger, threaded; .220" high bushing, flat	Solder lug	Silver	60,000 cycles
TP12SH9ABE	SPST Off-Mom.	.155" high plunger, unthreaded; .220" high bushing, flat	Right angle, PC thru-hole	Gold	30,000 cycles





### 8020 SERIES Snap-acting Momentary Pushbutton Switches

**Features / Benefits**

Positive tactile feel  
Epoxy terminal seal compatible with bottom wash cleaning  
Operating life 60,000 cycles

**Typical Applications**

Telecommunications and networking equipment  
Computers peripherals  
Instrumentation and controls

**Contact Rating**

Gold: 0.4 VA max. @ 20 V AC or DC max.  
Gold over silver: 1 AMP @ 120 V AC or 28 V DC

PART NUMBER	Function	Actuator or Bushing	Bushing	Mounting Style / Termination	Contact Material	Cap / Frame Color
8121SHZGE	SPDT On-Mom.	Plunger	.250" high, flat	Solder lug	Gold over silver	None
8125SHZBE	SPDT On-Mom.	Plunger	.250" high, flat	Solder lug	Gold	None
8221SHZGE	DPDT On-Mom.	Plunger	.250" high, flat	Solder lug	Gold over silver	None
8121J81ZGE22	SPDT On-Mom.	Snap-in with frame	None	Solder lug	Gold over silver	Black / Black
8125SHCBE	SPDT On-Mom.	Plunger	.250" high, flat	PC thru-hole	Gold	None

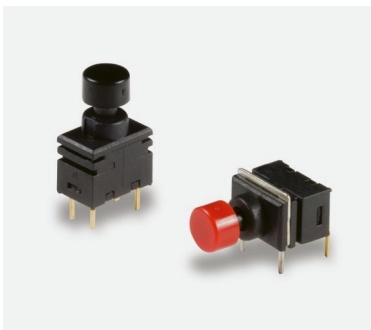

### FP SERIES Sealed Ultra Miniature Pushbutton Switches

**Features / Benefits**

Sealed against soldering and cleaning processes

**Typical Applications**

Networking equipment  
Modems  
Reset functions  
Instrumentation

**Contact Rating:**

0.4 VA (28 V DC or V AC) max.  
Operating life 50,000 cycles

PART NUMBER	Function	Actuator Length	Mounting Style	Contact Material	Cap
FP11SPC1B1TP00	SPST Off-Mom.	3.3 mm	Vertical	Gold over nickel plate	No cap
FP11SPA1B1TP02	SPST Off-Mom.	3.3 mm	Right angle	Gold over nickel plate	Black cap (bulk bagged)
FP11SPC1B1TP02	SPST Off-Mom.	3.3 mm	Vertical	Gold over nickel plate	Black cap (bulk bagged)
FP11SPA1B1TP03	SPST Off-Mom.	3.3 mm	Right angle	Gold over nickel plate	Red cap (bulk bagged)
FP11SPC1B1TP03	SPST Off-Mom.	3.3 mm	Vertical	Gold over nickel plate	Red cap (bulk bagged)



### PVA SERIES Short Stroke Key Switches

#### Features / Benefits

Compact design  
Short stroke to latch  
Wide variety of actuator heights and styles  
Adapted for medium power applications

#### Typical Applications

Automotive (air conditioning, lighting)  
Industrial  
Control panel

PART NUMBER	Function	Mechanical Function	Total Height	Travel	Operating Force
PVA1EEH1 3.5N V2	DPST	Push-push	17.5 mm	2.4 mm	3.5 N
PVA10AH1 1.2N V2	DPST	Momentary	17.5 mm	2.4 mm	1.2 N
PVA2EEH3 1.2N V2	DPDT	Push-push	20.5 mm	2.4 mm	1.2 N
PVA20AH5 1.7N V2	DPDT	Momentary	13 mm	2.4 mm	1.7 N



### PS SERIES Push Switches

#### Features / Benefits

Compact miniature size  
Momentary or latching  
Shorting or non-shorting

#### Typical Applications

Automotive interior lighting  
Computer peripherals  
Appliances  
Consumer electronics

PART NUMBER	Function	Footprint	Height	Operating Force	Operating Life	Total Travel
PS-12G01	SPDT, latching	16.8 x 14 mm	26.4 mm	400 gf	20,000 cycles	5 mm
PS-12G03	SPDT, latching	16.8 x 14 mm	27.2 mm	650 gf	20,000 cycles	4.5 mm
PS-2214-L NS PA	DPDT, latching	5.8 x 5.8 mm	7.5 mm	150 gf	10,000 cycles	2.3 mm
PS-2214-F NS PA	DPDT, momentary	5.8 x 5.8 mm	7.5 mm	150 gf	10,000 cycles	2.3 mm



**AP SERIES**  
**Sealed Industrial Pushbutton Switches**

**Features / Benefits**

IP67 sealed  
 Operating life 500,000 to 1,000,000 cycles  
 Illumination / Non-illumination, Multiple colored caps  
 SPST, normally open

**Contact Rating:**

200 mA @ 24 V DC resistive (500,000 cycles)  
 100 mA @ 50 V DC resistive (500,000 cycles)  
 400 mA @ 32 V AC resistive (500,000 cycles)  
 125 mA @ 125 V AC resistive (1,000,000 cycles)

**Typical Applications**

Harsh environments  
 Off-road  
 Industrial  
 Medical  
 Transportation  
 Joystick control modules  
 Gaming  
 Military

PART NUMBER	Operating Force	Total Travel	Actuator Style	Actuator Color	Bushing Style	Termination	Contact Material
AP2D200TWBE	2 N	2.1 ± 0.2 mm	Dome / Convex	Black	Threaded plastic	12" wire leads 22 AWG	Gold
AP4D200TZBE	4 N	2.1 ± 0.2 mm	Dome / Convex	Black	Threaded plastic	Solder lug	Gold
AP2D300SZBE	2 N	2.1 ± 0.2 mm	Dome / Convex	Red	Snap-in plastic	Solder lug	Gold
AP4E300TZBE	4 N	2.1 ± 0.2 mm	Extended Dome	Red	Threaded plastic	Solder lug	Gold



**APB SERIES**  
**Backlit Pushbutton Switches**

**Features / Benefits**

IP67 sealed  
 1,000,000 life cycle  
 Illumination  
 Threaded or snap-in mounting  
 RoHS compliant

**Typical Applications**

Harsh environments  
 Off-road  
 Transportation  
 Joystick control modules  
 Gaming  
 Military

PART NUMBER	Operating Force	Total Travel	Cap Symbol *	Actuator Color	Bushing Style	Termination	Contact Material
APB4E01TZBE-001	4 N	2.1 ± 0.2 mm	Plus	Black	Threaded plastic	Solder lug	Gold
APB4E01TZBE-002	4 N	2.1 ± 0.2 mm	Lock	Black	Threaded plastic	Solder lug	Gold

\* See C&K full line catalog or website for complete options for symbols



**NP SERIES**  
Sealed Industrial Pushbutton Switches

**Features / Benefits**

IP68 sealed  
Multiple housing styles

**Contact Rating:**  
10 mA / 5 VDC resistive (1,000,000 cycles)  
1 A / 32 VDC resistive (100,000 cycles)  
5 A / 32 VDC resistive (25,000 cycles)  
3 A / 32 VDC inductive (25,000 cycles)

**Typical Applications**

Harsh environments  
Off-road  
Industrial  
Transportation  
Military

PART NUMBER	Operating Force	Total Travel	Actuator Style	Actuator Color	Housing Style	Termination	Contact Material
NP8S2D203QE	8 N	1.6 ± 0.15 mm	Standard	Black	Dome bezel	Solder lug	Silver
NP8S2R203QE	8 N	1.6 ± 0.15 mm	Standard	Black	Rear mount	Solder lug	Silver
NP8S2T203QE	8 N	1.6 ± 0.15 mm	Standard	Black	Std threaded mount	Solder lug	Silver
NP8S3D203QE	8 N	1.6 ± 0.15 mm	Standard	Red	Dome bezel	Solder lug	Silver
NP8S2D2W4QE	8 N	1.6 ± 0.15 mm	Standard	Black	Dome bezel	4 x 12" 22 AWG UL 1569 wire	Silver



**PNP SERIES**  
Sealed Industrial Pushbutton Switches

**Features / Benefits**

IP68 sealed to endure harsh environments  
Multiple housing styles  
Longer solder leads for ease of wire installation  
Up to 5 A resistive load

**Contact Rating:**  
Silver (Q): 5 A / 32 VDC resistive (25,000 cycles)  
3 A / 32 VDC resistive (25,000 cycles)  
Gold (G): 10 mA / 5 VDC resistive (1,000,000 cycles)

**Typical Applications**

Control grips  
Off-road panels  
Heavy equipment  
Industrial instruments  
Lifts  
Conveyor controls

PART NUMBER	Operating Force	Total Travel	Actuator Style	Actuator Color	Housing Style	Circuit	Termination	Contact Material
PNP8S2T2C03GE	8 N	2 mm max.	Standard	Black	Standard	SPDT	Solder lug	Gold
PNP8S2T2C03QE	8 N	2 mm max.	Standard	Black	Standard	SPDT	Solder lug	Silver
PNP8S2D2YW2QE	8 N	2 mm max.	Standard	Black	Dome	SPST NC	2 x 12" 22 AWG UL 1569 wire	Silver
PNP8S2T2CW3QE	8 N	2 mm max.	Standard	Black	Standard	SPDT	3 x 12" 22 AWG UL 1569 wire	Silver



### ATP SERIES Anti-Vandal Pushbuttons

#### Features / Benefits

Momentary or lock version  
 IP67 sealed  
 Various colors of LED illuminate indicator  
 Choices of CAP with symbol of Ring, Spot or Power logo

#### Typical Applications

Control panels for car park & traffic light  
 Lifts / Escalator  
 Alarm, safety and security systems  
 Intercom "push-to-talk" devices  
 Food & drink vending machines

PART NUMBER	Size	Function	Actuator Style	Actuator Indicator	Bushing Type	Termination	Contact Material
ATP16-DL1-000-B4SA-04G	16 mm	SPST, momentary	Dome	Ring	Al alloy (anodized)	Solder lug	Gold flash
ATP16-DL5-606-B3SA-04G	16 mm	SPST, momentary	Dome	Ring & power	Al alloy (black anodized)	Solder lug	Gold flash
ATP16-SL1-612-M4SA-04G	16 mm	SPST, momentary	Standard / Flat	Ring	Stainless DD	Solder lug	Gold flash
ATP19-SL3-624-B0DA-03Q	19 mm	DPDT, momentary	Standard / Flat	Ring (moving)	Stainless round	STD Solder lug	Silver
ATP19-SL4-612-M0DE-03Q	19 mm	DPDT, lock	Standard / Flat	Power	Stainless DD	STD Solder lug	Silver
ATP19-SL1-324-B0SE-03Q	19 mm	SPDT, lock	Standard / Flat	Ring (fix)	Stainless round	STD Solder lug	Silver
ATP22-SL3-724-B0SE-03Q	22 mm	SPDT, lock	Standard / Flat	Ring (moving)	Stainless round	STD Solder lug	Silver
ATP22-SL3-312-B0SA-03Q	22 mm	SPDT, momentary	Standard / Flat	Ring (moving)	Stainless round	STD Solder lug	Silver



### PLP16 SERIES Panel Mount LED Sealed Pushbutton Switches

#### Features / Benefits

Illuminated & non-illuminated type  
 Momentary or lock version  
 IP65 or IP40 sealed  
 Choices of colors on LED illumination  
 Various actuator sizes & styles

#### Typical Applications

Industrial control panel  
 Off-road transportation  
 Machine & equipment  
 Production control indicator

PART NUMBER	Function	Actuator Style	Actuator Color	LED Voltage	IP Rating
PLP1600RD6SA6	Mom. SPDT	Round	Green		IP65
PLP1624RD3DE6	Lock. DPDT	Round	Red	24	IP65
PLP1624SQ3DE6	Lock. DPDT	Square	Red	24	IP65
PLP1624SQ6SE4	Lock. SPDT	Square	Green	24	IP40
PLP1624TA3SA6	Mom. SPDT	Rectangular	Red	24	IP65
PLP16C1RD3SE6	Lock. SPDT	Round	Solid Red		IP65
PLP16C1SQ3SA4	Mom. SPDT	Square	Solid Red		IP40
PLP16C2TA6SA6	Mom. SPDT	Rectangular	Trans. Green		IP65

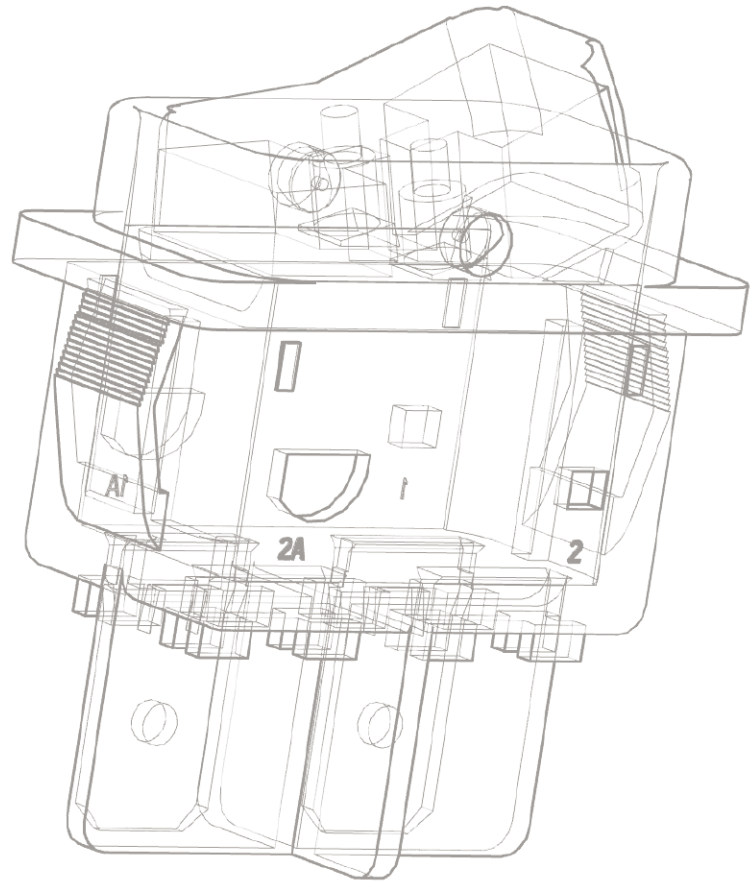
**PRODUCT SELECTION GUIDE**

# Rocker Switches

A rocker switch is an electrical on / off switch that rocks from one side to the other when pressed, leaving one side raised and the other depressed. This rocking mechanism will either connect or disconnect an electrical circuit. C&K's selection of rocker switches includes subminiature, miniature and power, providing an extensive range for printed circuit board through-hole, surface mount and panel mount applications. Models are available in illuminated (LED and neon) and sealed / waterproof versions, with SPST, SPDT, DPST, DPDT, 3PDT and 4DPT functionality. PCB mount options include vertical, right angle and surface mount, while panel mount options include front mount, rear mount and snap-in versions.



SERIES	7000	E	ET	T	9000	DA
Switch Type	Miniature	Miniature	Subminiature	Subminiature	Power rocker & lever handle	Miniature power
Poles / Throws	SPDT / DPDT / 3PDT / 4PDT	SPDT / DPDT / 3PDT	SPST / SPDT / DPDT	SPST / SPDT / DPDT	DPDT	SPST / SPDT
Max. Current	5 Amps	7.5 Amps	3 Amps	3 Amps	10 Amps	16 Amps 10 Amps
Washable		•	•			
Illuminated						•
PCB Mount Options						
Front Mount	•	•		•	•	Snap-in
Rear Mount	•	•	•	•	•	
PCB Mount Options						
Vertical	•	•	•	•	•	•
Right Angle	•	•	•	•	•	•
Surface Mount			•			



SERIES	D	DM	DM	DF	CR	SW
Switch Type	Miniature power	Miniature, 2 pole power	Miniature, illuminated, power	Power	Round	Miniature, power
Poles / Throws	SPST / SPDT / DPST / DPDT	DPST / DPDT	SPST / DPST	SPST / SPDT / DPST	SPST / SPDT	SPST / SPDT / DPST
Max. Current	4 Amps 10 Amps	3 Amps / 10 Amps	3 Amps / 10 Amps	16 Amps	10 Amps / 6 Amps	3 A / 6 A / 6.5 A / 10 A / 16 A
Washable						
Illuminated			•		•	•
PCB Mount Options						
Front Mount	Snap-in	Snap-in	Snap-in	Snap-in	Snap-in	Snap-in
Rear Mount				•		
PCB Mount Options						
Vertical	•					
Right Angle	•			•		
Surface Mount						

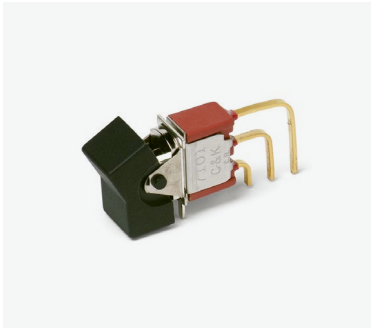

**7000 SERIES**  
**Miniature Rocker & Lever Handle Switches**

**Features / Benefits**

Multi-pole and multi-position  
 Wide variety of actuator and termination options  
 Epoxy terminal-seal compatible with bottom wash cleaning

**Typical Applications**

Telecommunications  
 Instrumentation  
 Medical equipment

**Contact Rating:**

Gold 0.4 VA MAX. @ 20 V AC or DC MAX.  
 Silver 5 AMPS @ 120 V AC or 28 V DC, 2 AMPS @ 250 V AC

PART NUMBER	Function	Actuator	Mounting Style / Termination	Contact Material	Electrical Life
7101J1AV2QE2	SPDT On-None-On	.531" long rocker	Vertical right angle, PC thru-hole	Silver	100,000 cycles
7101J1AQE2	SPDT On-None-On	.531" long rocker	Right angle, PC thru-hole	Silver	100,000 cycles
7101J1ABE2	SPDT On-None-On	.531" long rocker	Right angle, PC thru-hole	Gold	100,000 cycles



**E SERIES**  
**Sealed Miniature Rocker and Lever Handle Switches**

**Features / Benefits**

Sealed against solder and cleaning process contaminants  
 ESD Resistance—all actuator options  
 Rocker, case & bushing UL 94V-0

**Typical Applications**

Telecommunications  
 Instrumentation  
 Computers & peripherals

**Contact Rating:**

Gold 0.4 VA max. @ 20 V AC or DC max.  
 Silver 7.5 AMPS@125 V AC or 28 V DC, 3 AMPS @ 250 V AC

PART NUMBER	Function	Actuator	Mounting Style / Termination	Contact Material	Electrical Life
E101J1AQE2	SPDT On-None-On	.531" long rocker	Right angle, PC thru-hole	Silver	40,000 cycles
E201J1V31QE2	DPDT On-None-On	.531" long rocker	.460" high, V-bracket, snap-in	Silver	40,000 cycles
E101J3V31QE2	SPDT On-None-On	.906" long rocker	.460" high, V-bracket, snap-in	Silver	40,000 cycles





**D SERIES**  
**Miniature Snap-in Power Rocker Switches**

**Features / Benefits**

Momentary and maintained models  
 PC and quick connect terminals  
 Recessed bracket available — prevents accidental actuation

**Typical Applications**

Small appliances  
 Computers and peripherals  
 Medical instrumentation

**Contact Rating:**

Refer to full line catalog online  
 Contact Material Silver

PART NUMBER	Function	Mounting Style / Color	Mounting Style / Termination	Markings	Electrical Life
D502J12S2AHQA	SPST, On-None-Off	Snap-in, black	Right angle, PC thru-hole	O I	10,000 cycles
D101J12S215PQA	SPDT, On-None-On	Snap-in, black	PC thru-hole	O -	10,000 cycles
D501J12S2AHQA	SPDT, On-None-On	Snap-in, black	Right angle, PC thru-hole	O I	10,000 cycles



**DF SERIES**  
**Power Rocker Switches**

**Features / Benefits**

Power switching up to 16 AMPS  
 Sub-panel and front-panel mounting  
 Multi-position and multi-pole function  
 Available in UL94V-0 grade materials

**Typical Applications**

Overhead fan on range / hood  
 Small and large appliances

**Contact Rating:**

16 AMPS @ 125, 250 V AC, 1/4 HP @ 125 V AC  
 1/2 HP @ 250 V AC, 6 AMPS @ 48 V DC (UL)

PART NUMBER	Function	Housing Style / Color	Mounting Style / Termination	Contact Material	Electrical Life	Markings
DF62J12S2AHQA	DPST, Off-On	Sub-panel, black	Right angle, PC thru-hole	Silver (UL)	10,000 cycles	O I
DF62J12S2APQA	DPST, Off-On	Sub-panel, black	Right angle, PC thru-hole	Silver (UL)	10,000 cycles	O-
DF62J12S215PQA	DPST, Off-On	Sub-panel, black	Quick connect	Silver (UL)	10,000 cycles	O-



**SW SERIES**  
**Power Rocker Switches**

**Features / Benefits**

Oval shape  
Several color options (black, white, almond, biscuit)  
Front panel mounting

**Contact Rating:**  
6.5 AMP @ 125 V AC

**Typical Applications**

Computers  
Power supplies  
Appliances  
Fitness equipment  
Off-road vehicles

**PART NUMBER**

**SW-13A65N-A01 BK**

**SW-13A65N-A01**

**Function**

SPDT, On-Off-On

SPDT, On-Off-On

**Actuator**

Concave (curved)

Concave (curved)

**Color**

Black

White

**Termination**

Quick connect

Quick connect

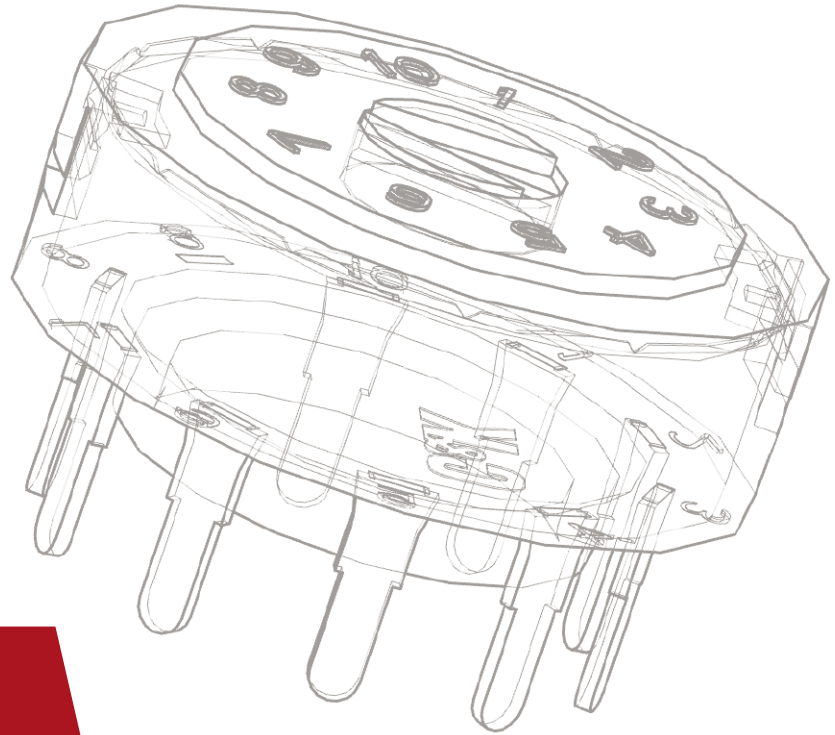
**PRODUCT SELECTION GUIDE**

# Rotary Switches

Rotary switches from C&K are available in a variety of indexing options for applications ranging from 10 mA to 12 Amps. With multi-pole, multi-position, half-inch, rota-slide, power rota-slide and sub-miniature switch type designs, C&K rotary switches feature shorting and non-shorting contacts for maximum design flexibility.



SERIES	A	RTA	M	R	F	H	RW	RM	ENC
<b>Switch Type</b>	Multi-pole / Multi-position	Multi-pole / Multi-position	Half-inch	Rota-slide	Rota-slide	Power Rota-slide	Sub-miniature rotary SMT	Sub-miniature rotary	Optical encoder
<b>Miniature</b>					•		•	•	
<b>Low Profile</b>					•		•		
<b>Screwdriver Slot</b>	•	•	•	•	•			•	
<b>Power</b>						•			
<b>Maximum Current</b>	2.5 Amps	5 A 1 A	6 Amps	5 Amps	4 Amps	12 Amps	0.1 A 10 mA	0.5 Amps	30 mA
<b>Poles</b>	1-4	1-4 (except 3)	1 & 2	1 & 2	1 & 2	1 & 2	1	1	1
<b>Indexing</b>	30° / 45° / 90°	22.5° / 30° / 36°	30° / 36°	36°	45° & 90°	45°	36° & 45°	45°	22.5°
<b>Splashproof</b>	•		•						
<b>Sealed</b>			• F option						
<b>Non-shorting / Shorting Contacts</b>	•								
<b>Panel Mount Options</b>									
<b>Top Mount</b>									•
<b>Rear Mount</b>	•	•	•	•	•	•			
<b>PCB Mount Options</b>									
<b>Vertical</b>	•	•	•	•	•		•		
<b>Terminations</b>									
<b>Solder Lug</b>	•	•	•	•	•	•			
<b>Wire Lead</b>				•	•	•			
<b>Quick Connect</b>						•			
<b>PC Connector</b>	•	•	•	•	•		•	•	
<b>Connector</b>									•



**A SERIES**  
**1-4 Pole Rotary Switches**

**Features / Benefits**

Multi-pole and multi-position  
Positive detent  
Shorting & non-shorting contacts  
Panel and PCB mounting  
Electrical life 15,000 make-and-break cycles at full load up to 300,000 detent operations

**Typical Applications**

Automotive  
Major and small appliances  
Industrial equipment

PART NUMBER	Function	Contact Rating	Mounting Style / Termination	Contact Material	Seal
A10305RNCB	SP, 30° Index, 3 pos. non-shorting	0.4 VA MAX. @ 20 V AC or DC MAX	PC thru-hole	Gold	None
A11405RNZQ	SP, 90° Index, 2 pos. non-shorting	SWITCH-2.5 AMPS @ 125 V AC; 350 mA @ 125V DC (UL/CSA). CARRY-5 AMPS CONTINUOUS	Solder lug	Silver	None
A20605RNCQK	DP, 30° Index, 6 pos. non-shorting	SWITCH-2.5 AMPS @ 125 V AC; 350 mA @ 125V DC (UL/CSA). CARRY-5 AMPS CONTINUOUS	PC thru-hole	Silver	Epoxy & splashproof bushing seal



**R SERIES**  
**ROTA-SLIDE® Rotary Switches**

**Features / Benefits**

Multi-pole and multi-position  
Positive detent  
Panel and PCB mounting  
Enclosed  
Electrical life 10,000 make-and-break cycles at full load

**Typical Applications**

Ceiling fans  
Industrial equipment  
Portable tools

**Contact Rating:**

5 AMPS @ 125 V AC, 2.5 AMPS @ 250 V AC  
0.5 AMP @ 125 V DC (UL)  
1/8 HP @ 125 and 250 VAC (UL)

PART NUMBER	Function	Actuator	Mounting Style	Mounting Style / Termination
R20507RR02Q	DP, 36° Index, 5 pos.	.500" high with .156" flat	3/8-32 threaded bushing	PC thru-hole
R20407RR03Q	DP, 36° Index, 4 pos.	.500" high with .156" flat	3/8-32 threaded bushing	Solder lug with hole
R10815RS02Q	SP, 36° Index, 8 pos.	Screwdriver slot without bushing	PC without bushing	PC thru-hole



**ENC SERIES**  
**Subminiature Rotary Switches**

**Features / Benefits**

- Clear detent / haptic feel
- Two channel, 2-bit code output
- Quadrature (incremental type)
- Integrated pushbutton

**Typical Applications**

- Automotive interior control
- Industrial equipment
- Test & instrumentation
- Medical equipment

**PART NUMBER**

**ENCOS16DS5C**

**Function**

1 pole 16 position

**Contact Rating**

Rotary: 30 mA @ 5 V DC  
 Pushbutton: 10 mA @  
 5 V DC

**Actuation Force**

600 ± 20% gf

**Operating Life**

300,000 cycles

**Termination**

SMT

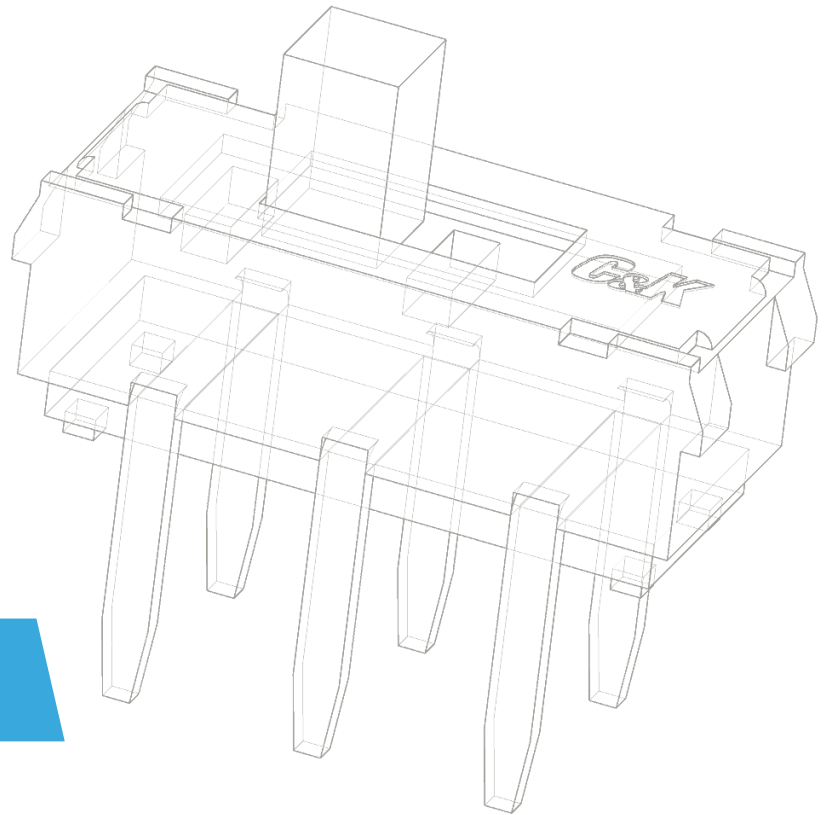

## PRODUCT SELECTION GUIDE

# Slide Switches

Featuring large size slide switches for power applications and small or medium size for low current or signal level applications. Our slide switches are compatible with the most standard soldering processes. Wave soldering and Reflow processes for switch placement at PCB level and also manual soldering and spot welding for typical value add solutions with wire leads or wire harnesses. Available in SPST, SPDT, SP3T, DPST, DPDT, 3PDT, 4PDT and 4P3T functions. Most of our designs include positive detent, sealing properties and selection in between Make-Before Break or Break-Before Break contacts.



SERIES	JS	SS	1000	OS	L	AYZ	PCM	SK
<b>Switch Type</b>	Small	Small	Medium	Small	Large	Small	Small	Small
<b>Travel (mm)*</b>	2 mm	Min: 2 Max: 5	Min: 2.16 Max: 2.41	2	Min: 3.30 Max: 4.06	1.5	1.5	Min: 2 Max: 4
<b>Rating (max.)</b>	0.3 A 6 VDC	0.3 A 6 VDC or 30 VDC	6 A 20 VAC or VDC	0.1 A 12 VDC	4 A 125 VAC or 28 VDC	100 mA 12 VDC	0.3 A 6 VDC	0.3 A 30 VDC
<b>Poles</b>	1 or 2	1, 2 or 4	1 or 2	1 or 2	1 or 2	1 or 2	1	1, 2 or 4
<b>No. of Position (Throws)</b>	1, 2 or 3	1, 2, 3 or 4	1 or 2	1, 2 or 3	1, 2, 3 or 4	1, 2 or 3	1, 2 or 3	1, 2, 3 or 4
<b>Min. Mount Height - Top Actuator</b>	3.5 mm		6.35 mm	4 mm	9.09 mm	1.5 mm		
<b>Min. Mount Height - Right Angle</b>	0.7 mm	3.5 mm	6.6 mm	3.9 mm	7.92 mm	1.5 mm	1.4 mm	3 mm
<b>Momentary (MOM) or Maintained</b>	MOM or Maintained	Maintained	MOM or Maintained	Maintained	MOM or Maintained	Maintained	Maintained	Maintained
<b>Tape &amp; Reel</b>	•						•	
Terminations								
<b>Wire Wrap</b>			•		•			
<b>Quick Connect</b>			•					
<b>Wire Lead</b>					•			
<b>Solder Lug</b>			•	•	•			
<b>PC</b>	•	•	•	•	•	•	•	•
Terminations								
<b>Thru-hole</b>	•	•	•	•	•			•
<b>Vertical</b>	•	•	•	•	•			
<b>Right Angle</b>	•		•	•				•
<b>Surface Mount</b>	•					•	•	
Terminations								
<b>Snap-in</b>								
<b>Mounting Ears</b>			•	•	•			
<b>Right Angle</b>			•					





SERIES	V	JSM	JSX	ES	TS	GS	LP	S
<b>Switch Type</b>	Large	Small	Small	Small	Small	Small	Large	Large
<b>Travel (mm)*</b>	6.60	2.7	1.3	2.29	3.05	1.02	3.68	4.57
<b>Rating (max.)</b>	10 A 125 VAC or 30 VDC	0.3 A 4 VDC	10 mA 5 VDC	0.02 A 20 VAC or VDC	3 A 20 VAC or VDC	0.02 A 20 VAC or VDC	11 A 125 VAC or 28 VDC	6 A or 15 A 125 VAC or 20 VDC
<b>Poles</b>	1 or 2	1	1	1 or 2	1	1	1 or 2	1 or 2
<b>No. of Position (Throws)</b>	1 or 2	1, 2, 3 or 4	2	1 or 2	1 or 2	1 or 2	1 or 2	1 or 2
<b>Min. Mount Height - Top Actuator</b>	15.75 mm	2 mm		6.38 mm	5.08 mm	5.38 mm	8.13 mm	7.11 mm
<b>Min. Mount Height - Right Angle</b>	15.75 mm	2 mm	1.2 mm	10.03 mm	9.81 mm	5.38 mm		
<b>Momentary (MOM) or Maintained</b>	Maintained	MOM or Maintained	MOM	Maintained	Maintained	Maintained	Maintained	MOM or Maintained
<b>Tape &amp; Reel</b>		•	•	•		•		
<b>Terminations</b>								
<b>Wire Wrap</b>					•			
<b>Quick Connect</b>	•							•
<b>Wire Lead</b>							•	•
<b>Solder Lug</b>							•	•
<b>PC</b>	•			•	•	•		•
<b>Terminations</b>								
<b>Thru-hole</b>	•			•	•	•	•	•
<b>Vertical</b>	•			•	•	•	•	•
<b>Right Angle</b>	•			•	•	•		•
<b>Surface Mount</b>		•	•	•		•		
<b>Terminations</b>								
<b>Snap-in</b>	•						•	•
<b>Mounting Ears</b>	•							•
<b>Right Angle</b>	•			•	•	•		•

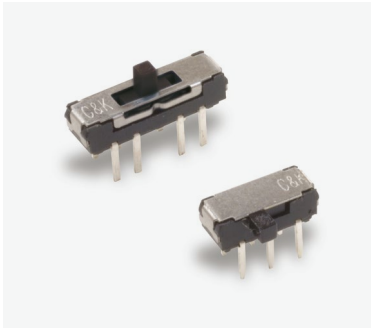

### JS SERIES Sub-Miniature Slide Switches

#### Features / Benefits

Positive detent  
Low profile  
IR reflow to 260° solder profile

**Contact Rating:**  
0.3A @ 6 V DC

#### Typical Applications

Telecommunication products  
Computer peripherals  
Thermostat select switch  
Instrumentation  
Medical

PART NUMBER	Function	Mounting Style / Termination	Contact Material	Electrical Life
JS102011JAQN	SPDT	Right angle - surface mount	Copper alloy, silver plated	5,000 cycles
JS207011SCQNR	DP3T	Surface mount	Copper alloy, silver plated	5,000 cycles
JS102011SAQN	SPDT	Right angle - surface mount	Copper alloy, silver plated	5,000 cycles



### SS SERIES Miniature Slide Switches

#### Features / Benefits

Various circuit design, SPDT, 4P3T, vertical, right angle  
Compact miniature slide switch  
Shorting or non-shorting  
Custom design available

#### Typical Applications

Consumer electronics  
Computer peripherals  
Telecommunication  
Audio & visual equipment  
Medical

PART NUMBER	Function	Contact Rating	Actuator	Travel	Termination	Electrical Life
SS-12D07-VG 4 NS GA PA	SPDT, non-shorting	0.3 A @ 30 V DC	4 mm	2 mm	PC thru-hole	10,000 cycles
SS-12D1505-G 2	SPDT, non-shorting	0.3 A @ 6 V DC	2 mm	2 mm	PC thru-hole	10,000 cycles
SS-14D08-VG 5 PA	1P4T	0.3 A @ 30 V DC	5 mm	2 mm	PC thru-hole	10,000 cycles
SS-22D0205-G 2	DPDT, non-shorting	0.3 A @ 6 V DC	2 mm	2 mm	PC thru-hole	10,000 cycles
SS-22D07-G 2 NS PA	DPDT, non-shorting	0.3 A @ 30 V DC	4 mm	2 mm	PC thru-hole	10,000 cycles

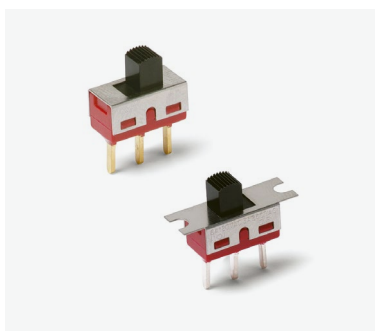

### 1000 SERIES Miniature Slide Switches

#### Features / Benefits

Variety of actuators and terminations  
 Panel mount tabs available  
 Epoxy terminal seal—compatible with bottom-wash cleaning

#### Contact Rating:

Gold 0.4 VA max. @ 20 V AC or DC max.  
 Silver 6 AMPS @ 120 V AC or 28 V DC, 3 AMPS @ 250 V AC

#### Typical Applications

Test & measurement equipment  
 Telecommunications  
 Computer & peripherals

PART NUMBER	Function	Mounting Style	Actuator	Mounting Style / Termination	Contact Material	Electrical Life
1101M2S3CQE2	SPDT On-None-On	PC mount without tabs	.200" high	PC thru-hole	Silver	40,000 cycles
1101M2S3AV2QE2	SPDT On-None-On	PC mount without tabs	.200" high	Vertical right angle, PC thru-hole	Silver	40,000 cycles
1101M2S3AQE2	SPDT On-None-On	PC mount without tabs	.200" high	Right angle, PC thru-hole	Silver	40,000 cycles
1201M2S1CQE2	DP On-None-On	Panel mount with tabs	.200" high	PC thru-hole	Silver	40,000 cycles



### OS SERIES Miniature Slide Switches

#### Features / Benefits

Variety of actuators & terminations  
 PC and panel mounting  
 Gold or silver plating available  
 Shorting or non-shorting contacts

#### Contact Rating:

0.1 A @ 12 V DC

#### Typical Applications

Test & measurement equipment  
 Computer peripherals & network products  
 Consumer products

PART NUMBER	Function	Mounting Style	Actuator	Travel	Contact Material	Electrical Life
OS103011MS8QP1	SP3T, On-On-On, non-shorting	Vertical	H: 4 mm	2 mm	Copper alloy, silver plated	10,000 cycles
OS102011MS2QN1	SPDT, On-On, non-shorting	Vertical	H: 4 mm	2 mm	Copper alloy, silver plated	10,000 cycles
OS202011MS2QS1	DPDT, On-On, shorting	Vertical	H: 4 mm	2 mm	Copper alloy, silver plated	10,000 cycles
OS202011MA0QN1	DPDT, On-On, non-shorting	Right angle	L: 4 mm	2 mm	Copper alloy, silver plated	10,000 cycles

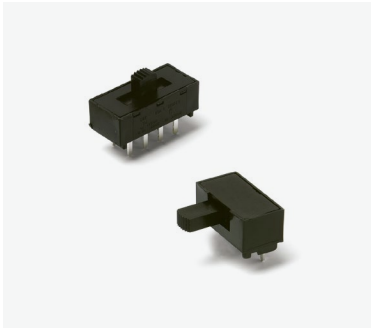

**L SERIES**  
**Miniature Slide Switches**

**Features / Benefits**

- Positive detent
- Enclosed housing
- Maintained and momentary functions
- PC and panel mounting

**Contact Rating:**

- 4 AMPS @ 125 V AC or 28 V DC
- 2 AMPS @ 250 V AC
- 0.5 AMP @ 125 V DC (UL)

**Typical Applications**

- Communications equipment
- Lighting devices

PART NUMBER	Function	Actuator	Mounting Style / Termination	Contact Material	Electrical Life
L203111MS02Q	DP3T	0.100" high	PC thru-hole	Silver	10,000 cycles
L103111MS02Q	SP3T	0.100" high	PC thru-hole	Silver	10,000 cycles
L20202MA04Q	DPDT	0.335" high	Right angle, PC thru-hole	Silver	10,000 cycles
L212132MV02QE	DPDT-MOM	Plunger without cap	PC thru-hole	Silver	10,000 cycles



**AYZ SERIES**  
**Miniature Slide Switches**

**Features / Benefits**

- Low profile
- Single & double pole models
- Double & triple throw models

**Contact Rating:**

- 100 mA @ 12 V DC

**Typical Applications**

- Computer peripherals & network products
- Telecommunication products
- Test & measurement equipment
- Medical

PART NUMBER	Function	Actuator	Termination	Contact Material	Electrical Life
AYZ0202AGRLC	DPDT, On-On	H: 1.0 mm	SMT	Copper alloy, silver plated	10,000 cycles
AYZ0102AGRLC	SPDT, On-On	L: 1.0 mm	SMT	Copper alloy, silver plated	10,000 cycles
AYZ0203AGRLC	DP3T, On-On-On	H: 1.0 mm	SMT	Copper alloy, silver plated	10,000 cycles



**PCM SERIES**  
Sub-Miniature Slide Switches

**Features / Benefits**

Ultraminiature surface mount  
Low profile  
SPDT & SP3T models  
RoHS compliant

**Typical Applications**

Computer peripherals & network product  
Telecommunication products  
Test & measurement equipment  
Medical

PART NUMBER	Function	Mounting Style / Termination	Contact Material	Electrical Life
PCM12SMTR	SPDT	SMT, right angle	Copper alloy, silver plated	10,000 cycles
PCM13SMTR	SP3T	SMT, right angle	Copper alloy, silver plated	10,000 cycles

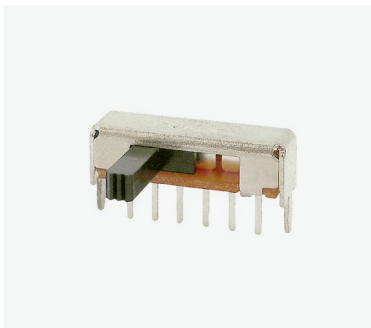

**SK SERIES**  
Miniature Slide Switches

**Features / Benefits**

Various circuit design, SPDT, 4P3T, vertical, right angle  
Compact miniature slide switch  
Shorting or non-shorting  
Custom design available

**Typical Applications**

Consumer electronics  
Computer peripherals  
Telecommunication  
Audio & visual equipment  
Medical

PART NUMBER	Function	Contact Rating	Actuator	Travel	Termination	Electrical Life
SK-12D04-VG 3 NS	SPDT, non-shorting	0.3 A @ 30 V DC	3 mm	2 mm	PC thru-hole	10,000 cycles
SK-12D07-G 5 NS PA	SPDT, non-shorting	0.3 A @ 30 V DC	5 mm	2 mm	PC thru-hole	10,000 cycles
SK-12D07-VG 4 NS PA	SPDT, non-shorting	0.3 A @ 30 V DC	4 mm	2 mm	PC thru-hole	10,000 cycles
SK-13D21-G 2 RT	1P3T, non-shorting	0.3 A @ 4 V DC	2 mm	2 mm	SMT	10,000 cycles
SK-14D01-G6	1P4T	0.3 A @ 30 V DC	6 mm	2 mm	PC thru-hole	10,000 cycles



**V SERIES**

**Power & Line Voltage Select Slide Switches**

**Features / Benefits**

Actuator with screwdriver slot

**Contact Rating:**

- 10 GPA @ 125 V AC 50/60 Hz T85
- 5 GPA @ 250 V AC 50/60 Hz T85
- 2 (0.5) A @ 250 V AC 50/60 Hz T85
- 4RA @ 30 VDC T85

**Typical Applications**

Appliances

PART NUMBER	Function	Mounting Style	Mounting Style / Termination	Contact Material	Electrical Life
V80212MS02Q	DPDT	PC thru-hole	PC thru-hole	Silver	10,000 cycles
V80212MA08Q	DPDT	Right angle, PC thru-hole	Right angle PC thru-hole	Silver	10,000 cycles
V80212S205Q	DPDT	Snap-in panel	Quick connect	Silver	10,000 cycles

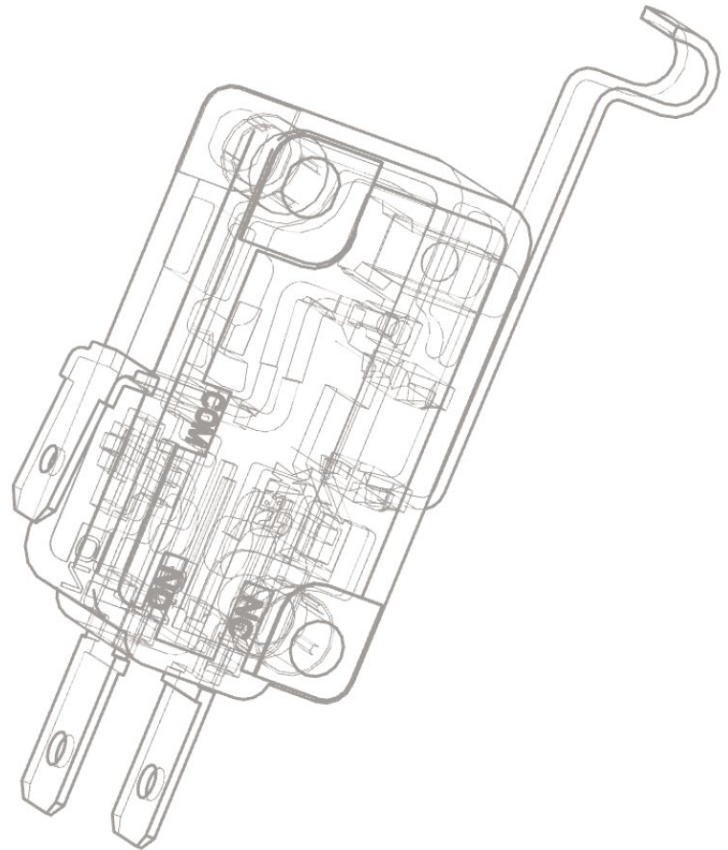

## PRODUCT SELECTION GUIDE

# Snap-acting Switches

C&K's broad range of snap switches includes subminiature, miniature, and metal case models. These limit switches have a variety of actuator configurations (pin plunger, lever, and roller lever), electrical ratings from low levels up to 30 Amps, and a broad range of operating forces. Terminal styles include PCB through-hole, quick connect, wire leads, screw, solder, formed PC through-hole, flat and step base. Sealed models are available as is SPST, SPDT, DPST and DPDT functionality. Mounting options include vertical or right angle, PCB and snap-in mounting.

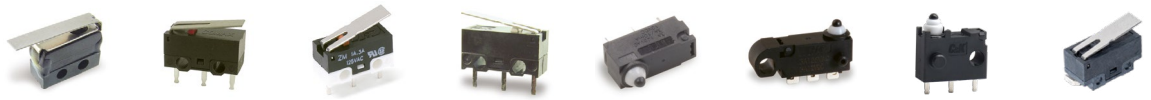

SERIES	MM	MS	ZM	ZMA	ZMS	ZMSM	ZMW	ZPA
<b>Switch Type</b>	Mini Size	Mini Size	Mini Size	Mini Size	Mini Size	Mini Size	Mini Size	Mini Size
<b>Poles / Throws</b>	SPDT	SPDT	SPDT	SPDT	SPDT	SPDT	SPST, SPDT	SPDT
<b>Maximum Current</b>	7 Amps	3 Amps	3 Amps	3 Amps	3 Amps	3 Amps	0.1 Amps	0.1 Amps
Terminations								
<b>Solder</b>				•	•	•	•	•
<b>Quick Connect</b>							•	
<b>Wire Leads</b>					•	•	•	
<b>Screw</b>								
<b>PCB Thru-hole</b>	•	•	•	•	•	•	•	
<b>Flat &amp; Step Base</b>								
<b>Bushing</b>								
<b>Sealed</b>					•	•	•	

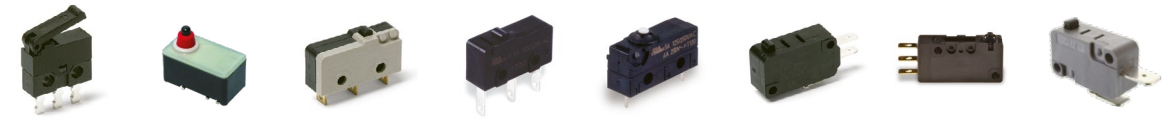

SERIES	MDS	SSW	LC	LCA	LCS	TF	TFS	TF3
<b>Switch Type</b>	Mini Size	Mini Size	Small Size	Small Size	Small Size	Mid Size	Mid Size	Mid Size
<b>Poles / Throws</b>	SPDT	DPDT	SPST, SPDT	SPDT	SPST	SPST, SPDT	SPDT	SPST
<b>Maximum Current</b>	300 m Amps	20 Amps	10.1 Amps	10 Amps	6 Amps	21 Amps	10 Amps	25 Amps
Terminations								
<b>Solder</b>	•		•	•	•	•		
<b>Quick Connect</b>			•	•	•	•	•	•
<b>Wire Leads</b>			•		•		•	
<b>Screw</b>								
<b>PCB Thru-hole</b>	•							
<b>Flat &amp; Step Base</b>								
<b>Surface Mount</b>		•						
<b>PC</b>			•	•	•			
<b>Formed PC</b>			•	•	•			
<b>Extended Operations</b>			•	•		•	•	
<b>Sealed</b>					•		•	





SERIES	TM	HB	A	TL	DS
<b>Switch Type</b>	Mid Size	Large Heavy Duty	Large Heavy Duty	Large Heavy Duty	Large Heavy Duty
<b>Poles / Throws</b>	SPST, SPDT	SPST, SPDT	SPST, SPDT, DP	SPDT	SPST, SPDT
<b>Maximum Current</b>	15 Amps	20 Amps	30.1 Amps	15 Amps	0.1, 10, 16 A
Terminations					
<b>Solder</b>	•	•			
<b>Quick Connect</b>	•	•	•	•	•
<b>Wire Leads</b>					
<b>Screw</b>	•	•		•	
<b>PCB Thru-hole</b>					
<b>Flat &amp; Step Base</b>		•			
<b>Surface Mount</b>					
<b>PC Formed PC</b>					
<b>Bushing</b>		15/32-32	3/8-23		

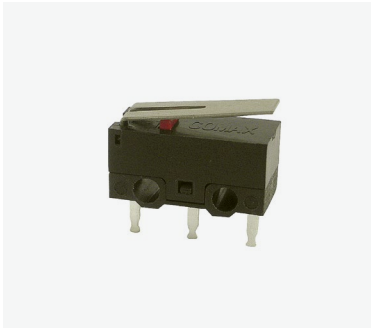

**MS SERIES**  
**Snap-acting Switches**

**Features / Benefits**

Detect interlock and movement  
Different lever options  
Various operating forces

**Typical Applications**

Industrial  
Consumer electronics  
Appliances

PART NUMBER	Function	Operating Force	Electrical Rating	Actuator	Termination
MS-118305-G	SP momentary	25 gf	0.1 A, 30 V DC	Lever ST 12.5 mm	PC thru-hole
MS-118405-H	SP momentary	25 gf	0.1 A, 30 V DC	Lever SR R1.3	Solder lug
MS-105A01 (H)	SP momentary	230 gf	5 A 125 V AC	Pin plunger	Solder lug



**ZMA SERIES**  
**Mini Size Snap-acting Switches**

**Features / Benefits**

Reliable snap-acting mechanism  
Long electrical and mechanical life  
Compact size—Ideal when space is limited  
Electrical life 300,000 cycles @ 0.1A / 10,000 cycles @ 3A

**Typical Applications**

PCB detection switch  
Communication devices  
Testing equipment  
Security / Alarm systems

PART NUMBER	Function	Electrical Rating	Operating Force	Actuator	Mounting Style / Termination
ZMA03A150S07EC	SPDT, momentary	3 A @ 125 V AC 24 V DC	150 grams	Simulated roller 0.75 mm	Solder
ZMA00A150L04PC	SPDT, momentary	0.1 A @ 125 V AC 60 V DC	150 grams	Lever 4.55 mm	PC thru-hole
ZMA03A150A03PC	SPDT, momentary	3 A @ 125 V AC 24 V DC	150 grams	Roller 1.87 mm	PC thru-hole



**ZMW SERIES**  
**Mini Size Snap-acting Switches**

**Features / Benefits**

Long and adequate stroke setting for high reliability and insulation  
 Silent for noiseless application  
 Compact size – ideal when space is limited  
 IP67

**Typical Applications**

Automotive  
 Industrial  
 Home appliances

PART NUMBER	Function	Electrical Rating	Operating Force	Actuator	Mounting Style / Termination
ZMW00AP00PCAA	SPDT	0.1 A 30 VDC	150 grams	Pin plunger	PC thru-hole
ZMW00AT10SCAA	SPDT	0.1 A 30 VDC	150 grams	Lever	



**ZPA SERIES**  
**Surface Mount Snap-acting Switches**

**Features / Benefits**

Reliable snap-acting mechanism  
 Long electrical and mechanical life  
 Subminiature packaging size  
 Surface mount terminations  
 RoHS compatible & compliant

**Typical Applications**

PCB detection switch  
 Communication devices  
 Testing equipment  
 Security / Alarm systems  
 Consumer electronics

PART NUMBER	Function	Operating Force	Electrical Rating	Actuator	Termination
ZPA00A150P00T	SPST	150 grams	0.1 A	Pin plunger	Surface mount



**SSW SERIES**  
**Mini Size 2 Pole Snap-acting Switches**

**Features / Benefits**

SMT  
 IP67  
 Redundant contacts  
 Change over time <15 ms  
 Top and side actuation

**Typical Applications**

Automotive, ASIL related applications  
 (electronic parking brake, by-wire functions)  
 Safety applications

PART NUMBER	Function	Operating Force	Electrical Rating	Actuator	Termination
SSW 115S	DPDT	2 N	20 mA, 18 V DC	Standard	Surface mount



**LC SERIES**  
**Small Size Precision Snap-acting Switches**

**Features / Benefits**

Compact design  
 Long life and high electrical capacity  
 Quick connect, wire lead or PC mounting  
 Wide variety of actuator styles

**Typical Applications**

Motorized equipment  
 Sump pump  
 Thermostatic controls

PART NUMBER	Function	Operating Force	Electrical Rating	Actuator	Termination
LCGHF5A10RCE	SPDT	6 oz. / 170 grams	1 A, 125, V AC, 30 V DC	.28" lever roller, high force	Right formed PC thru-hole
LCGGL9P00EC	SPDT	5 oz. / 142 grams	5 A, 1/3 HP, 125, 250 V AC	Pin plunger	Solder lug



**LCS SERIES**  
**Small Size Sealed Snap-acting Switches**

**Features / Benefits**

Compact design  
 Quick connect, solder terminals, PC terminals, wire leads  
 Wide variety of actuator styles  
 IP67  
 Electrical life 10,000 cycles

**Typical Applications**

Motorized equipment  
 Sump pump  
 Thermostatic controls  
 Computers  
 Air conditioners

PART NUMBER	Function	Operating Force	Actuator	Mounting Style/ Termination	Contact Rating
LCS051P00SDC	SPDT	150 grams	Pin plunger	Solder	5 AMP, 125/250 V AC
LCS011T05QDC	SPDT	150 grams	Short lever, 17.4 mm	0.110 quick connect	0.1 AMP, 125/250 V AC
LCS051P00PDC	SPDT	150 grams	Pin plunger	PC thru-hole	5 AMP, 125/250 V AC



**TF SERIES**  
**Mid Size Snap-acting Switches**

**Features / Benefits**

Broad range of operating forces  
 From low level\* to 21 AMPS @ 277 V AC  
 Wide variety of actuator styles

**Typical Applications**

Motor controls  
 Thermostatics  
 Portable tools

**PART NUMBER**

**TFCJL3SP004AC**

**Function**

SPDT momentary

**Operating Force**

5.29 oz. / 150 grams

**Electrical Rating**

20 A, 250 V AC; 1 HP,  
 125 V AC; 2 HP 250 V AC

**Actuator**

Pin plunger

**Termination**

.250" quick connect

**TFCDK6ST2640C**

SPDT momentary

.88 oz. / 25 grams

11 A, 277 V AC; 1/3 HP,  
 125, 250 V AC; 0.5 A,  
 125 V DC; 0.25 A,  
 250 V DC

2.57" lever, low force

.187" quick connect



**TF3 SERIES**  
**Mid Size Snap-acting Switches**

**Features / Benefits**

Broad range of operating forces  
 Rating up to 25 AMPS  
 Wide variety of actuator styles  
 Extreme operating temperature up to 125°C

**Typical Applications**

Heavy duty power tools  
 Motor controls  
 HVAC

**PART NUMBER**

**TF325CFP0040Y**

**Function**

SPST

**Operating Force**

190 grams

**Electrical Rating**

25A

**Actuator**

Pin plunger

**Termination**

Quick connect



**A SERIES**  
General Purpose Snap-acting Switches

**Features / Benefits**

Low cost—high performance  
Long electrical life  
Sealed actuator option available

**Typical Applications**

Enclosure equipment  
Garage door openers  
Vending machines

PART NUMBER	Function	Operating Force	Electrical Rating	Actuator	Termination
ASKHC2T04AC	SPDT	20 oz. / 567 grams	15 A, 125, 250 V AC 3/4 HP, 125 V AC 1 1/2 HP, 250 V AC	Lever	.250" quick connect
ADPDC2T04AC	DPDT	30 oz. / 850 grams	15 A, 125, 250 V AC 3/4 HP, 125 V AC 1 1/2 HP, 250 V AC	Lever	.250" quick connect
ASKHC2J04AC	SPDT	20 oz. / 567 grams	15 A, 125, 250 V AC 3/4 HP, 125 V AC 1 1/2 HP, 250 V AC	High overtravel plunger	.250" quick connect



**DS SERIES**  
Interlock Pushbutton Switches

**Features / Benefits**

Snap-in mounting  
Reliable snap action mechanism  
Latch or momentary  
Halogen free material

**Typical Applications**

Interlock switch  
Detection switch  
Circuit interrupt

PART NUMBER	Function	Contact Rating	Actuator	Terminals
DS1D6AQ1	SPDT	10 (4) A @125/250 V AC 50/60 Hz 50,000 cycles, 10 A G.P. @ 125 / 250 V AC 1/3HP @ 125/250 V AC 50/60 Hz 10,000 cycles	Momentary, short button	4.8 x 0.5 mm
DS2D6BQ1	DPDT	10 (4) A @125/250 V AC 50/60 Hz 50,000 cycles, 10 A G.P. @ 125 / 250 V AC 1/3HP @ 125/250 V AC 50/60 Hz 10,000 cycles	Momentary, long button	4.8 x 0.5 mm
DS2D6CQ1	DPDT	10 (4) A @125/250 V AC 50/60 Hz 50,000 cycles, 10 A G.P. @ 125 / 250 V AC 1/3HP @ 125/250 V AC 50/60 Hz 10,000 cycles	Momentary, pulled out button	4.8 x 0.5 mm

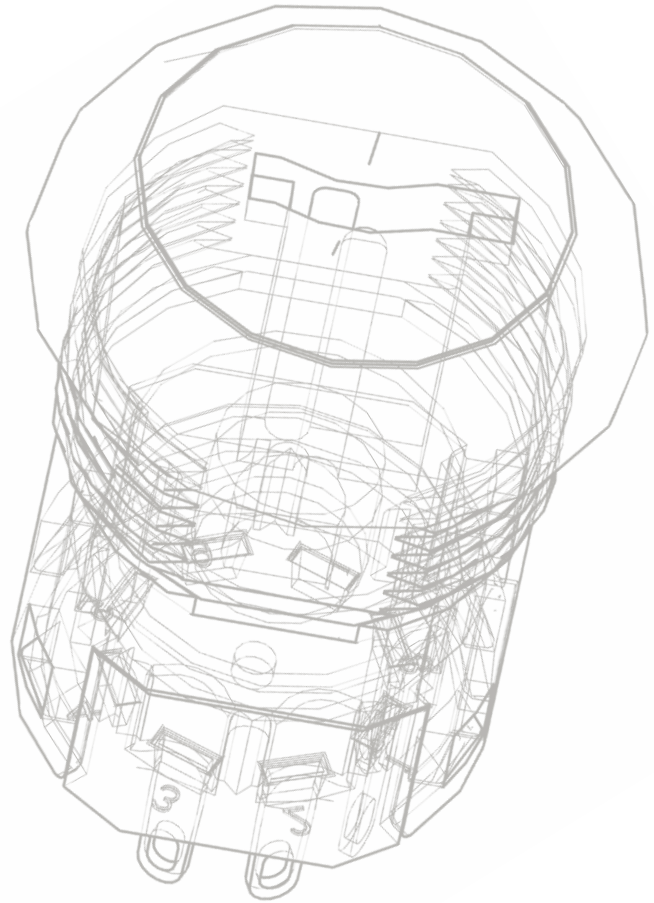

## PRODUCT SELECTION GUIDE

# Switchlocks

Available in plastic or metal housings, C&K's switchlocks feature 4 to 6 tumblers supporting a variety of security needs. Miniature, anti-static and momentary versions combine with bushing or snap-in mounting for a broad product selection.



SERIES	Y	YF	YM	PM
<b>Switch Type</b>	4, 5, 6 Tumbler	4 Tumbler	4 Tumbler	5 Tumbler
<b>Lock</b>	Metal	Metal	Metal	Plastic
<b>Latch Pawl</b>	•			
<b>Miniature</b>		•		•
<b>Anti-static</b>	•			
<b>Momentary</b>	•			
<b>Poles</b>	1 & 2	1 & 2	1	1
<b>Indexing</b>	45° & 90°	45° & 90°	90°	90°
<b>Max. Current</b>	4 Amps	4 Amps	4 Amps	4 Amps
Panel Mount Options				
<b>Snap-in</b>				•
<b>Bushing</b>	•	•	•	
<b>PC Thru-hole</b>	•			



SERIES	A	H	PL
<b>Switch Type</b>	4 & 5 Tumbler	4 & 6 Tumbler	5 Tumbler
<b>Lock</b>	Metal	Metal	Plastic
<b>Cam</b>			•
<b>Miniature</b>			•
<b>Anti-static</b>	•		
<b>Momentary</b>			
<b>Poles</b>	1 - 4	1 & 2	
<b>Indexing</b>	30°, 45° & 90°	45° & 90°	90°
<b>Max. Current</b>	2.5 Amps	12 Amps	
Panel Mount Options			
<b>Snap-in</b>			•
<b>Bushing</b>	•	•	
<b>Thru-hole</b>	•		





### Y SERIES 4, 5 & 6 Tumbler Switchlocks

#### Features / Benefits

Anti-static switch—exceeds 20 KV DC static resistance  
 Momentary models available  
 Wire leads and harnesses available

#### Contact Rating:

4 AMPS @ 125 V AC or 28 V DC, 2 AMPS @ 250 V AC (UL/CSA)  
 Electrical Life 10,000 make-and-break cycles at full load

#### Typical Applications

Point-of-sale terminals  
 Cash registers  
 Computers

PART NUMBER	Function	Keying	Lock Type	Termination
Y201132C203NQ	DP, 90°, keypull pos. 1	Two nickel plated brass keys (4 & 5 tumbler) or two die cast zinc alloy keys with chrome plating (6 tumbler)	4 Tumbler lock with detent	Solder lug with hole
Y1011U2C203NQ	SP, 90°, keypull pos. 1 & 2	Two nickel plated brass keys (4 & 5 tumbler) or two die cast zinc alloy keys with chrome plating (6 tumbler)	4 Tumbler lock with detent	Solder lug with hole
Y101132C203NQ	SP, 90°, keypull pos. 1	Two nickel plated brass keys (4 & 5 tumbler) or two die cast zinc alloy keys with chrome plating (6 tumbler)	4 Tumbler lock with detent	Solder lug with hole



### H SERIES 4 & 6 Tumbler Power Switchlocks

#### Features / Benefits

Positive detent  
 Multi-pole and multi-position  
 Snap-together assembly  
 Power switching

#### Contact Rating:

Silver: 12 AMPS @ 125 V AC, 6 AMPS @ 250 V AC, 1 AMP @ 125 V DC (UL/CSA)  
 Gold: 0.4 VA Max. @ 20 V AC or DC Max.  
 Electrical life 10,000 make-and-break cycles at full load

#### Typical Applications

Machine controls  
 Elevators

PART NUMBER	Function	Keying	Lock Type	Termination	Termination
H1011U2F205NQ	SP, 90° Index, keypull pos. 1 & 2	Two nickel plated brass keys	4 Tumbler lock with detent	Quick connect	Silver
H201132F205NQ	DP, 90° Index, keypull pos. 1	Two nickel plated brass keys	4 Tumbler lock with detent	Quick connect	Silver
H200AA2F205NQ	DP, 45° Index, keypull pos. 1, 2 & 3	Two nickel plated brass keys	4 Tumbler lock with detent	Quick connect	Silver

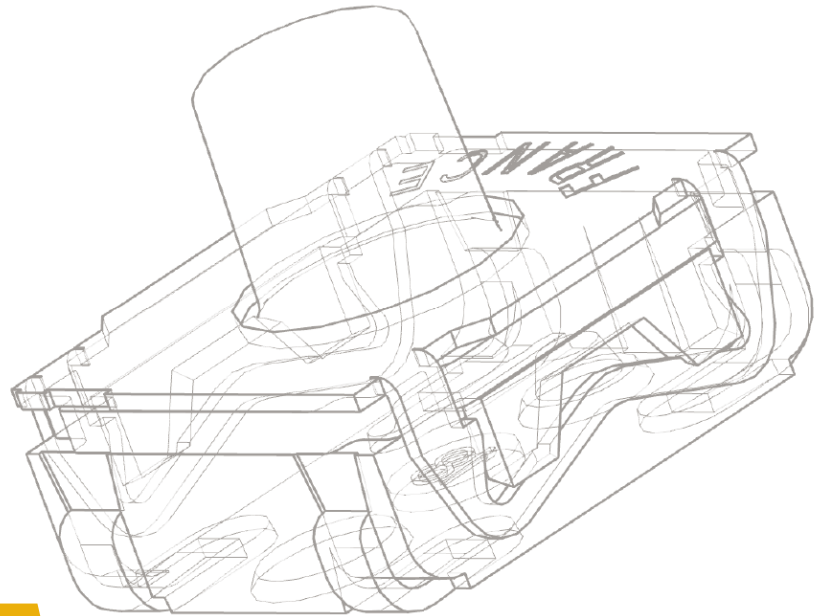
**PRODUCT SELECTION GUIDE**

# Tactile Switches

C&K offers a broad range of miniature tactile, ultra-miniature tactile and micro miniature tactile switches for printed circuit board mounting. Available in J bend, gull wing, illuminated, sealed, low-profile, low-noise, SMT and through hole versions, C&K's tactile switches are designed for the most demanding applications.



Surface Mount

SERIES	KXT3	KMT0	KMT2	KMR2-9	KMS	PTS525	PTS526
<b>Size on PCB L x W (mm)</b>	3 x 2	3 x 2.6	3 x 2.6	4.2 x 2.8	4.2 x 3.55	5.2 x 5.2	5.2 x 5.2
<b>Total Height (mm)</b>	0.6	0.65	0.65	1.9 / 2.5	1.42	0.8 and 1.5	0.8 / 1.5 / 1.7 / 2.0
<b>Travel (mm)</b>	0.13	0.15	0.15	0.2 to 0.35	0.25 to 0.3	0.25	0.25
<b>Actuation Force (N)</b>	100 gf / 160 gf / 240 gf / 330 gf	1.0 / 1.6 / 2.3 / 3.4	1.0 / 1.6	1.2 / 2.0 / 3.0 / 4.0	2.0 / 3.0	160 gf / 260 gf	160 gf / 260 gf / 320 gf
<b>Contact Type</b>	Silver	Silver	Silver	Silver / Gold	Silver / Gold	Silver	Silver
<b>Max. Voltage (V)</b>	15	32	32	32	32	15	12
<b>Max. Switching Power (VA)</b>	0.5	0.5	0.5	1 / 0.2	1 / 0.2	0.3	0.6
<b>Life Cycles</b>	300,000 / 500,000	300,000 / 600,000 / 1,000,000	150,000	100,000 / 300,000	100,000	200,000 to 1,000,000	150,000 to 500,000
<b>IP Rating</b>	IP54	IP68	IP54	IP40 / IP67	IP40	IP40	IP40



Surface Mount

SERIES	PTS530	PTS540	PTS810	PTS815	PTS820	PTS830	PTS840
<b>Size on PCB L x W (mm)</b>	4.5 x 4.5	3.7 x 3.7	4.2 x 3.2	4.2 x 3.2	3.9 x 2.9	3.5 x 2.6	3.5 x 3.55
<b>Total Height (mm)</b>	0.55 and 0.65	0.35	2.5	2.5	1.5 / 2.0 / 2.5	1.4	1.35
<b>Travel (mm)</b>	0.2	0.15	0.15 / 0.2	0.2	0.2	0.15	0.2
<b>Actuation Force (N)</b>	100 gf / 160 gf / 200 gf / 260 gf / 400 gf / 600 gf	160 gf / 230 gf	160 gf / 260 gf / 400 gf / 600 gf	180 gf / 250 gf / 400 gf	160 gf / 250 gf	160 gf / 450 gf	160 gf / 220 gf
<b>Contact Type</b>	Silver	Silver	Silver	Silver	Silver	Silver	Silver
<b>Max. Voltage (V)</b>	12	12	16	12	12	12	12
<b>Max. Switching Power (VA)</b>	0.6	0.6	0.8	0.6	0.6	0.6	0.6
<b>Life Cycles</b>	150,000 to 1,000,000	300,000 to 500,000	50,000 to 150,000	100,000	100,000 to 200,000	200,000 to 1,000,000	100,000
<b>IP Rating</b>	IP40	IP40	IP40	IP40	IP40	IP40	IP40

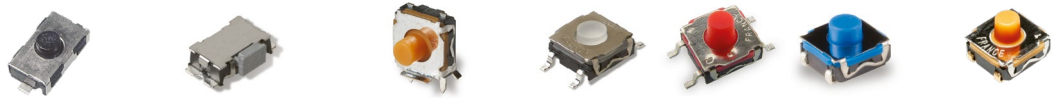

Surface Mount Thru-Hole Options

SERIES	KSR	KSS	KSC4V2	KSC1-10		KSC DCT
<b>Size on PCB L x W (mm)</b>	7.15 x 3.8 / 7.3 x 3.8	5.5 x 4.4	2 holes $\phi$ 1.1 / 2 pads 1.5 x 0.8	J 6.8 x 6.2	G 10 x 6.2	6.8 x 6.2
<b>Total Height (mm)</b>	2.5	1.7	5.0*			5.2
<b>Travel (mm)</b>	0.3 to 0.5	0.3	0.7*	0.20 to 0.75 *		0.85
<b>Actuation Force (N)</b>	1.2 / 2.0 / 3.0 / 45	2 / 2.5 / 4	3.5*	1.1 to 5.5 *		4.75
<b>Contact Type</b>	Silver / Gold	Silver / Gold	Silver / Gold	Silver / Gold		Silver
<b>Max. Voltage (V)</b>	32	32	32	32		32
<b>Max. Switching Power (VA)</b>	1 / 0.2	1 / 0.2	1 / 0.2	1 / 0.2		1
<b>Life Cycles</b>	100,000 / 200,000	100,000	300,000	100,000 to 1,000,000		300,000
<b>IP Rating</b>	IP50	IP40	IP67	IP67		IP67



Surface Mount Thru-Hole Options

SERIES	KSC PF	KSC OF	KSC TE	KSC SLT	KSE	KT
<b>Size on PCB L x W (mm)</b>	6.8 x 6.2	6.8 x 6.2	6.8 x 6.2	6.8 x 6.2	6.8 x 6.2	SA 7.5 x 5 SA2 7.5 x 7
<b>Total Height (mm)</b>	5.2	5.2	3.5	5	3.1 / 4.3	6.6 / 7.11 with tab
<b>Travel (mm)</b>	0.5 to 1.0	0.5 to 0.75	0.25 to 0.35	1.35	0.3	0.3 to 0.5
<b>Actuation Force (N)</b>	1.7 to 6.25	1.65 / 4	1.6 to 4	2.4 / 3.5	1.5 / 2.25	3
<b>Contact Type</b>	Silver	Silver	Silver	Silver / Gold	Silver	Silver / Gold
<b>Max. Voltage (V)</b>	32	32	24	32	32	50
<b>Max. Switching Power (VA)</b>	1	1	0.03	1 / 0.2	1	1 / 0.2
<b>Life Cycles</b>	300,000 to 1,000,000	300,000 to 1,000,000	5,000,000 to 10,000,000	200,000	300,000	100,000
<b>IP Rating</b>	IP67	IP 67	IP67	IP40	IP67	



Surface Mount Thru-Hole Options

SERIES	K5AT	K8	K5V	KSF/KSI	KSA	KSA-V
<b>Size on PCB L x W (mm)</b>	G 8.4 x 10.8	G 8.4 x 10.8	8 x 9 x 17 / 9 x 13	7.62 x 5.08	7.62 x 5.08	7.62 x 2.54
<b>Total Height (mm)</b>	6.1	6	9 / 13	2.6	4.7 button option	8
<b>Travel (mm)</b>	0.5	0.45	1.2	0.3 to 0.5	0.3 to 0.5	0.3 to 0.5
<b>Actuation Force (N)</b>	4.0	4.0	4.0	1.3 / 1.6 / 3.0 / 5.0	1.3 / 3.0 / 5.0	1.3 / 3.0 / 5.0
<b>Contact Type</b>	Gold	Silver	Gold	Silver / Gold	Silver / Gold	Silver / Gold
<b>Max. Voltage (V)</b>	32	32	32	32	32	32
<b>Max. Switching Power (VA)</b>	1	1	1	1 / 0.2		
<b>Life Cycles</b>	100,000	300,000	25,000	100,000	100,000	100,000
<b>IP Rating</b>	IP40	IP40	IP40	IP60	IP60	IP60



Surface Mount Thru-Hole Options

SERIES	KSA MKII	KSL	KSL-V	KSJ	KSJ-V	PTS636
<b>Footprint</b>	7.62 x 5.08	7.62 x 5.08	7.62 x 2.54	7.62 x 5.08	7.62 x 2.54	6 x 3.5
<b>Total Height (mm)</b>	4.7	9.9	8	6.65	8	2.5 / 4.3 / 5.0
<b>Travel (mm)</b>	0.3 to 0.5	0.3 to 0.5	0.3 to 0.5	0.55 to 0.7	0.55 to 0.7	0.25 to 0.30
<b>Actuation Force (N)</b>	1.3 / 3.0 / 5.0	1.3 / 3.0	1.3 / 3.0	2.0 / 3.0	2.0 / 3.0	130 gf / 180 gf / 250 gf / 320 gf
<b>Contact Type</b>	Silver / Gold	Silver / Gold	Silver / Gold	Silver / Gold	Silver / Gold	Silver
<b>Max. Voltage (V)</b>	32	32	32	32	32	12
<b>Life Cycles</b>	100,000 / 1,000,000	100,000	100,000	100,000	100,000 / 30,000	20,000 to 100,000
<b>IP Rating</b>	IP67	IP60	IP60	IP60	IP60	IP40



Surface Mount Thru-Hole Options

SERIES	PTS641	PTS645	PTS645-V	PTS647	PTS125	ITS
Footprint	6,3 x 6.4	6 x 6	7.0 x 7.9	4.5 x 4.5	12 x 12	Variety of sizes available
Total Height (mm)	2.5 / 3.1 / 3.4	4.3 / 5.0 / 7.0 / 7.3 / 9.5 / 13.0	7.0	3.8 / 5.0 / 7.0	4.3 / 7.3 / 8.5 / 12.0	6.2 / 7.0 / 7.1 / 7.2
Travel (mm)	0.20 / 0.30	0.25	0.25	0.25	0.30	0.25
Actuation Force (N)	160 gf / 250 gf / 320 gf	1.3 / 1.6 / 2.0 / 2.6	1.0 / 1.6	100 gf / 180 gf / 250 gf	1.8 / 2.5	160 gf
Contact Type	Silver	Silver	Silver	Silver	Silver	Silver
Max. Voltage (V)	12	12	12	12	12	12
Life Cycles	100,000	100,000 / 1,000,000	100,000	100,000	200,000 / 1,000,000	50,000
IP Rating	IP40	IP40	IP40	IP40	IP40	IP40

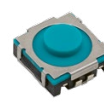
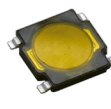
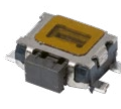

Surface Mount Thru-Hole Options

SERIES	ILS	NANOT	PTS841	RK	TLS
Footprint	Variety of sizes available	2.1 x 1.65 / 2.2 x 1.7	3.6 x 3.5	4.5 x 4.5 / 4.2 x 3.2 / 3.5 x 2.6	8.6 x 8.4
Total Height (mm)	7.0 / 7.2 / 9.0	0.55 / 1.65	1.25	0.55 / 2.5 / 1.4	3.95
Travel (mm)	0.25	0.1	0.2	0.15 / 0.2	0.75 / 0.9
Actuation Force (N)	180 gf / 250 gf	100 gf / 180 gf / 240 gf	180 gf / 250 gf	160 gf / 180 gf / 250 gf / 400 gf / 450 gf / 540 gf	4 / 7 / 10
Contact Type	Silver	Silver	Silver	Silver	Silver
Max. Voltage (V)	12	15	12	12 to 15	16
Life Cycles	100,000	200,000 / 300,000	100,000	100,000 to 500,000	300,000 to 1,000,000
IP Rating	IP40	IP67	IP40		IP54

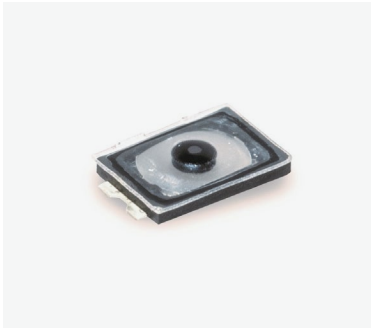

**KXT3 SERIES**

**Ultra Low Profile Top Actuated Tact Switches**

**Features / Benefits**

Smallest footprint 3.0 x 2.0 mm  
 0.6 mm thickness  
 High number of cycles

**Typical Applications**

Wearable electronics  
 In-ear headphones, earbuds  
 Portable electronics  
 Hearing aids

PART NUMBER	Operating Force	Contact Material	Operating Life	Travel
KXT 311 LHS	100 ± 50 gf	Silver	300,000 cycles	0.13 ± 0.05 mm
KXT 321 LHS	160 ± 50 gf	Silver	500,000 cycles	0.13 ± 0.05 mm
KXT 331 LHS	240 ± 70 gf	Silver	500,000 cycles	0.13 ± 0.05 mm



**KMT0 SERIES**

**Nano-miniature SMT Top Actuated Tact Switches**

**Features / Benefits**

3.0 x 2.06 mm footprint  
 IP68  
 Ultra low current capabilities

**Typical Applications**

Mobile phones  
 Hearing aids  
 MP3 accessories  
 Bluetooth headset

PART NUMBER	Operating Force	Contact Material	Operating Life	Travel
KMT011NGJ LHS	1.0 ± 0.25 N	Silver	300,000 cycles	0.15 ± 0.1 mm
KMT031NGJ LHS	3.4 ± 0.25 N	Silver	300,000 cycles	0.15 ± 0.1 mm
KMT071NGJ LHS	2.3 ± 0.25 N	Silver	300,000 cycles	0.15 ± 0.1 mm



**KMR SERIES**

**Microminiature SMT Top Actuated**

**Features / Benefits**

IP40 or IP67 sealing  
 Optional ground pin  
 Ultra low current capabilities  
 Heights: 1.9 mm & 2.5 mm

**Typical Applications**

Automotive  
 Consumer  
 Industrial electronics  
 Medical equipment

PART NUMBER	Operating Force	Contact Material	Operating Life	Travel
KMR211G LFS	1.2 ± 0.30 N	Silver	200,000 cycles	0.20 ± 0.1 mm
KMR621NG LFS	2.0 ± 0.50 N	Silver	200,000 cycles	0.25 ± 0.1 mm
KMR73N1G LFS	3.0 ± 0.75 N	Silver	150,000 cycles	0.25 ± 0.1 mm



**KMS SERIES**  
**Microminiature SMT Side Actuated**

**Features / Benefits**

- Compact size
- Excellent tactile feel
- Positioning pegs for stability
- IP40 sealing

**Typical Applications**

- Medical handheld monitors
- Consumer electronics
- Telecommunication networks

**PART NUMBER**

**KMS221G LFS**

**KMS231G LFS**

**Operating Force**

2.0 ± 0.5 N

3.0 ± 0.6 N

**Contact Material**

Silver

Silver

**Operating Life**

100,000 cycles

100,000 cycles

**Travel**

0.25 ± 0.15 mm

0.30 ± 0.15 mm



**PTS526 SERIES**  
**Microminiature SMT Top Actuated**

**Features / Benefits**

- 5.2 x 5.2 mm footprint
- Variable thickness
- Commercial grade

**Typical Applications**

- IoT devices
- Home automation
- Remote controls

**PART NUMBER**

**PTS526 SM 08 SMTR2 LFS**

**PTS526 SK G 15J SMTR2 LFS**

**PTS526 SP 20 SMTR2 LFS**

**Operating Force**

160 gf

250 gf

320 gf

**Total Height**

0.8 mm

1.5 mm

2.0 mm

**Operating Life**

500,000 cycles

200,000 cycles

100,000 cycles

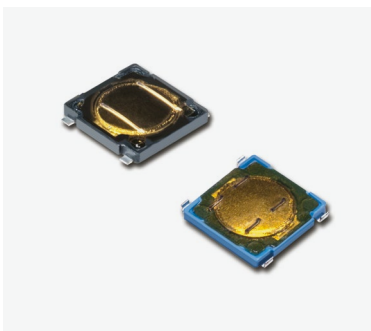

**PTS530 SERIES**  
**Ultra Low Profile SMT Top Actuated**

**Features / Benefits**

- 4.5 x 4.5 mm footprint
- 0.55 mm thickness
- High number of cycles
- Symbol line identification

**Typical Applications**

- MP3 accessories
- Bluetooth headset
- Remote controls
- Garage door opener

**PART NUMBER**

**PTS530GM055SMTRLFS**

**PTS530GK055SMTRLFS**

**Termination Style**

Gull wing

Gull wing

**Operating Force**

160 ± 30 gf

260 ± 30 gf

**Operating Life**

1,000,000 cycles

200,000 cycles

**Travel**

0.2 mm - 0.1 /+ 0.15 mm

0.2 mm - 0.1 /+ 0.15 mm



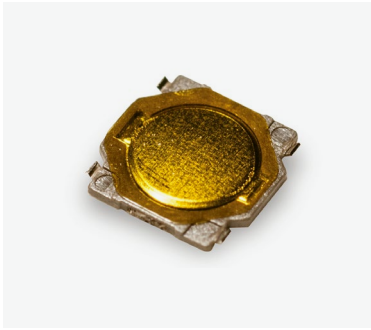

**PTS540 SERIES**  
**Microminiature SMT Top Actuated**

**Features / Benefits**

3.7 x 3.7 mm footprint  
 High number of cycles  
 0.35 mm thickness

**Typical Applications**

MP3 accessories  
 Bluetooth headset  
 Remote controls

**PART NUMBER**

**PTS540JM035SMTRLFS**  
**PTS540JK035SMTRLFS**

**Total Height**

0.35 mm  
 0.35 mm

**Operating Force**

160 ± 50 gf  
 230 ± 50 gf

**Operating Life**

500,000 cycles  
 300,000 cycles

**Travel**

0.15 +/- 0.1 mm  
 0.15 +/- 0.1 mm



**PTS815 SERIES**  
**Microminiature SMT Top Actuated**

**Features / Benefits**

4.2 x 3.2 mm footprint  
 2.5 mm thickness  
 Commercial grade

**Typical Applications**

IoT devices  
 Home automation  
 Remote controls

**PART NUMBER**

**PTS815 SJM 250 SMTR LFS**  
**PTS815 SJK 250 SMTR LFS**  
**PTS815 SJG 250 SMTR LFS**

**Actuator Color**

White  
 White  
 Black

**Operating Force**

180 ± 50 gf  
 250 ± 50 gf  
 400 ± 100 gf

**Operating Life**

100,000 cycles  
 50,000 cycles  
 100,000 cycles



**PTS820 SERIES**  
**Microminiature SMT Top Actuated**

**Features / Benefits**

3.9 x 2.9 mm footprint  
 Three different heights  
 High number of cycles  
 Reduced footprint

**Typical Applications**

Control panels  
 Nomad devices  
 Remote controls  
 Keyless entry system

**PART NUMBER**

**PTS820J25MSMTRLFS**  
**PTS820J25KSMTRLFS**

**Total Height**

2.5 mm  
 2.5 mm

**Pegs**

No  
 No

**Operating Force**

160 ± 50 gf  
 250 ± 50 gf

**Operating Life**

200,000 cycles  
 100,000 cycles



**PTS840 SERIES**  
**Microminiature SMT Side Actuated**

**Features / Benefits**

3.5 x 3.55 mm footprint  
 Front PIP leads option for strong shear resistance  
 ESD pin option

**Typical Applications**

Nomad devices  
 Remote controls  
 Personal health diagnostics  
 Consumer electronics

**PART NUMBER**

**PTS840PMSMTR LFS**

**PTS840GMPMTR LFS**

**PTS840GKPSMTR LFS**

**PTS840ESDPMSMTR LFS**

**Operating Force**

160 gf -40/+70 gf

160 gf -40/+70 gf

220 gf -70/+80 gf

160 gf -40/+70 gf

**Operating Life**

100,000 cycles

100,000 cycles

100,000 cycles

100,000 cycles

**Ground**

No

No

No

Yes

**Termination Style**

Pin in paste

Gull wing

Gull wing

Pin in paste

**Pegs**

No

Yes

Yes

No



**KSR SERIES**  
**Microminiature SMT Top Actuated**

**Features / Benefits**

4 actuation forces  
 N.O. and N.C.  
 Rubber actuator  
 IP50 sealed

**Typical Applications**

Automotive  
 Medical equipment  
 Industrial electronics  
 Smart meters

**PART NUMBER**

**KSR221G LFS**

**KSR231G LFS**

**KSR251G LFS**

**KSR223G NC LFG**

**KSR221G NC LFS**

**Operating Force**

2.2 N

3.0 N

4.5 N

2.0 N

2.25 N

**Contact Material**

Silver

Silver

Silver

Gold

Silver

**Switch Function**

Normally open

Normally open

Normally open

Normally closed

Normally closed

**Operating Life**

100,000 cycles

100,000 cycles

100,000 cycles

50,000 cycles

30,000 cycles

**Travel**

0.30 ± 0.15 mm

0.35 ± 0.15 mm

0.50 ± 0.15 mm

0.30 ± 0.15 mm

0.30 ± 0.15 mm

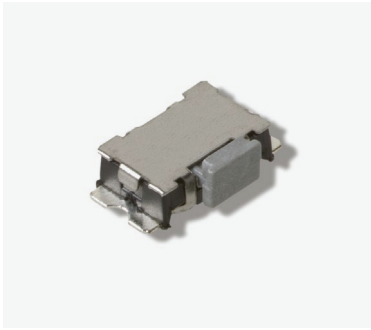

**KSS SERIES**  
Subminiature SMT Side Actuated

**Features / Benefits**

Low profile  
3 actuation forces  
IP40 sealed

**Typical Applications**

Mobile phone  
Industrial electronics  
Health diagnostic electronics

PART NUMBER	Operating Force	Contact Material	Switch Function	Operating Life	Travel
<b>KSS221G LFS</b>	2.0 ± 0.5 N	Silver	Normally open	100,000 cycles	0.30 ± 0.15 mm
<b>KSS231G LFS</b>	2.5 ± 0.5 N	Silver	Normally open	100,000 cycles	0.30 ± 0.10 mm
<b>KSS241G LFS</b>	4.0 ± 1 N	Silver	Normally open	100,000 cycles	0.30 ± 0.15 mm



**KSC4V2 SERIES**  
Side Actuated Sealed Tact Switches

**Features / Benefits**

Full SMT compatible side actuated  
Haptic adaptability  
Pin in paste terminations  
IP67

**Typical Applications**

Automotive  
Industrial  
Telecommunication networks  
Network infrastructure and IT

PART NUMBER	Operating Force	Contact Material	Operating Life	Travel
<b>KSC441V2SPD LFS</b>	3.5 ± 1.0 N	Silver	300,000 cycles	0.7 ± 0.2 mm

Other options: height, force, travel, operating life available on request

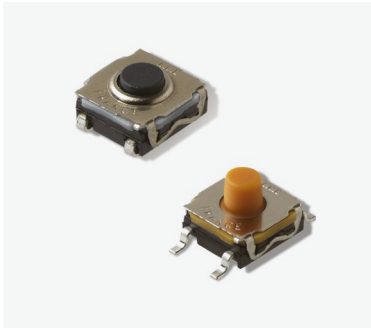

**KSC SERIES**  
Sealed Tact Switches for SMT

**Features / Benefits**

Full SMT compatible side actuated  
Haptic adaptability  
Pin in paste terminations  
IP67

**Typical Applications**

Automotive  
Industrial  
Telecommunication networks  
Network infrastructure and IT

PART NUMBER	Operating Force (Min /Max)	Actuator Height	Operating Life	Travel
KSC241J LFS	3.5 ± 0.9 N	3.5 ± 0.2 mm	300,000 cycles	0.5 ± 0.2 mm
KSC321J LFS	1.6 N	3.47 ± 0.2 mm	300,000 cycles	0.2 +0.3 mm
KSC441J 70SH LFS	4 ± 1 N	5.2 ± 0.2 mm	300,000 cycles	0.75 ± 0.25 mm
KSC441J ST2 LFS	3.4 ± 1 N	5.2 ± 0.2 mm	300,000 cycles	0.35 ± 0.20 mm
KSC641J LFS	3.4 ± 1 N	7.7 ± 0.2 mm	300,000 cycles	0.4 ± 0.2 mm
KSC841J OL LFS	3.4 ± 0.85 N	4.9 ± 0.2 mm	300,000 cycles	0.4 ± 0.2 mm
KSC941J LFS	3.4 ± 0.85 N	7.7 ± 0.2 mm	300,000 cycles	0.4 ± 0.2 mm



**KSC-DCT SERIES**  
Dual Circuit Technology Tact Switches

**Features / Benefits**

SPDT NC-NO function  
Silicone actuator  
J or G terminations  
IP67

**Typical Applications**

Automotive  
Medical equipment  
Industrial electronics

PART NUMBER	Operating Force	Contact Material	Operating Life	Travel
KSC441J DCT 70SH LFS	4.75 ± 1.25 N	Silver	300,000 cycles	0.85 + 0.35 / - 0.25 mm
KSC441G DCT 70SH LFS	4.75 ± 1.25 N	Silver	300,000 cycles	0.85 + 0.35 / - 0.25 mm



**KSC-PF SERIES**  
**Potting Friendly Tact Switches**

**Features / Benefits**

Extended cage  
 Silicone actuator  
 J or G terminations  
 IP67

**Typical Applications**

Automotive  
 Medical equipment  
 Industrial electronics

**PART NUMBER**

**KSC422J 70SH LFS PF**  
**KSC441G 70SH LFS PF**  
**KSC461J 70SH LFS PF**

**Operating Force**

1.8 ± 0.45 N  
 4 ± 1 N  
 6.25 ± 1.75 N

**Contact Material**

Silver  
 Silver  
 Silver

**Operating Life**

1,000,000 cycles  
 300,000 cycles  
 300,000 cycles

**Travel**

0.5 ± 0.25 mm  
 0.65 ± 0.25 mm  
 0.75 ± 0.25 mm



**KSC OF SERIES**  
**Overload Friendly Tactile Switches**

**Features / Benefits**

6.2 x 6.2 x 5.1 mm form factor  
 SMT versions J leads  
 Life time of 300,000 cycles at 20N actuation and 1 time overload at 200N

**Typical Applications**

Consumer  
 Power tool  
 Industrial  
 Medical  
 Automotive

**PART NUMBER**

**KSC421G 70SH LFS OF**  
**KSC441J 70SH LFS OF**

**Operating Force**

1.65  
 4

**Contact Material**

Silver  
 Silver

**Operating Life**

300,000 cycles  
 300,000 cycles

**Travel**

0.5  
 0.5



**KSC TE SERIES**  
**Tireless Endurance Tactile Switches**

**Features / Benefits**

6.2 x 6.3 mm form factor  
 SMT versions J leads  
 1.6N, 2.8N & 4N actuation forces

**Typical Applications**

Elevator  
 Game controller  
 Industrial  
 Mouse and peripherals for computers  
 Barcode scanner

**PART NUMBER**

**KSC2 TE 01J LFS**  
**KSC2 TE31J LFS**  
**KSC2 TE 41J LFS**

**Operating Force**

1.6  
 2.8  
 4

**Contact Material**

Silver  
 Silver  
 Silver

**Operating Life**

10,000,000 cycles  
 5,000,000 cycles  
 5,000,000 cycles

**Travel**

0.25  
 0.30  
 0.35

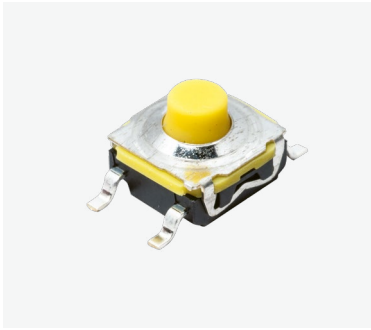

**KSC SLT SERIES**  
**Long Travel Low Sound Tactile Switches**

**Features / Benefits**

Actuator height 5.0 mm  
 IP40  
 6.2 x 6.2 form factor

**Typical Applications**

Automotive interior

PART NUMBER	Operating Force	Contact Material	Operating Life	Travel
KSC SLT 221G LFS	2.4	Silver	200,000 cycles	1.35
KSC SLT 223J LFS	2.4	Gold	200,000 cycles	1.35
KSC SLT 241J LFS	3.2	Silver	200,000 cycles	1.35

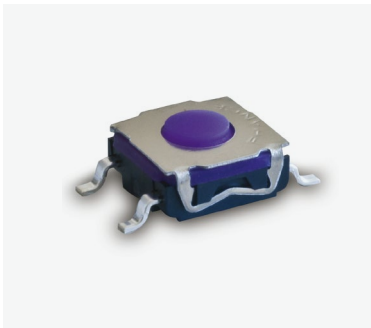

**KSE SERIES**  
**High Performance Sealed Tact Switches**

**Features / Benefits**

Low profile  
 IP67  
 Height 3.1 mm & 4.3 mm

**Typical Applications**

Smart meters  
 Home appliances / Consumer electronics  
 Industrial electronics  
 Telecommunications

PART NUMBER	Operating Force	Operating Life	Travel
KSEM31J LFS	1.5 ± 0.5 N	300,000 cycles	0.3 + 0.1/-0.2 mm
KSEK43G LFS	2.25 ± 0.75 N	300,000 cycles	0.30 ± 0.2 mm



**KT SERIES**  
**SMT Tact Switches**

**Features / Benefits**

Rubber or hard plastic actuator  
Press fit or snap fit caps  
Easy to pick & place with top plate tab

**Typical Applications**

Telecommunications  
Computer products  
Instrumentation

PART NUMBER	Actuator	Orientation	Mounting Bracket	Contact Material	Termination
KT11 B2 SAM 34 LFS	Soft 2.24 mm	Side actuated		Silver	SMT
KT11 P3 SA1M 34 LFS	Hard 1.12 mm	Side actuated	Front solder pad	Silver	SMT
KT11 P4 SA2M 35 LFG	Hard 3.96 mm	Side actuated	Solder pad and pick & place	Gold	SMT
KT11 B0 SA3M 34 LFS	Soft flush	Side actuated	Pick and place tab	Silver	SMT
KT11 P3 SM 34 LFS	Hard 1.12 mm	Top actuated	Gull wing	Silver	SMT



**PTS641 SERIES**  
**Miniature SMT Top Actuated**

**Features / Benefits**

6.3 x 6.3 mm footprint  
Multiple heights  
Ground pin option

**Typical Applications**

Metering  
White goods  
Home and garden equipment

PART NUMBER	Total Height	Operating Force	Operating Life	Ground Pin
PTS641SM31SMTR2LFS	3.1 mm	160 gf	100,000 cycles	No
PTS641TK25SMTR2LFS	2.5 mm	250 gf	100,000 cycles	No



**PTS645 SERIES**  
**Miniature SMT / THT Top / Side Actuated**

**Features / Benefits**

Compact size 6 x 6 mm  
 Variety of actuator lengths  
 Choice of actuator force

**Typical Applications**

Computer products  
 Industrial  
 Consumer products  
 Instrumentation

**PART NUMBER**

**PTS645SL43SMTR92 LFS**

**PTS645VH58-2 LFS**

**Total Height**

4.3 mm

6.2 mm

**Operating Force**

130 gf

200 gf

**Operating Life**

100,000 cycles

100,000 cycles

**Termination**

SMT

Vertical



**PTS647 SERIES**  
**4.5 mm Tact Switches**

**Features / Benefits**

Compact size 4.5 x 4.5 mm  
 SMT terminals  
 Different actuator heights  
 Choice of actuation forces

**Typical Applications**

Consumer  
 Industrial control panels  
 Computer products

**PART NUMBER**

**PTS647SN50SMTR2 LFS**

**Total Height**

5.0 mm

**Operating Force**

100 gf

**Operating Life**

100,000 cycles

**Travel**

0.25 ± 0.15 mm



**PTS125 SERIES**  
**Miniature SMT Top Actuated**

**Features / Benefits**

12 x 12 mm  
 Four different heights  
 THT and SMT termination  
 Snap fit actuator option

**Typical Applications**

Computer products  
 Industrial  
 Consumer products  
 Instrumentation

**PART NUMBER**

**PTS125SJM73 SMTR-2 LFS**

**PTS125SK43-2 LFS**

**Total Height**

7.3 mm

4.3 mm

**Operating Force**

180 gf

250 gf

**Operating Life**

200,000 cycles

200,000 cycles

**Termination**

SMT

THT





**ITS SERIES**  
**Illuminated Pushbuttons**

**Features / Benefits**

Vertical and right angle  
Thru-hole and SMT models  
Multiple caps and legends  
Several LED colors and bi-color options

**Typical Applications**

Consumer electronics  
Server / Storage  
Medical devices  
Test / Measurement / Instrumentation

PART NUMBER	LED Color	Mounting Style / Termination	Operating Life	Operating Force
ITS10FV1ST	Red	Vertical thru-hole	50,000 cycles	160gf ± 50 gf
ITS13FV2SR	Red / Green	Vertical SMT gull wing	50,000 cycles	160gf ± 50 gf
ITS50FV3SR	White	Vertical SMT gull wing with J bend LED	50,000 cycles	160gf ± 50 gf
ITS23FR1ST	Yellow / Green	Right angle thru-hole	50,000 cycles	160gf ± 50 gf
ITS40FR2ST	Blue	Right angle thru-hole 2.5 mm leads	50,000 cycles	160gf ± 50 gf



**ILS SERIES**  
**Integrated LED Tact Switches**

**Features / Benefits**

Red, yellow green, blue, white and green LED  
IP40  
THT versions

**Typical Applications**

Video broadcast systems  
Servers  
Software defined radio/ receivers

PART NUMBER	LED Color	Mounting Style / Termination	Operating Life	Operating Force
ILSTC18060	7N	Brass	500,000 cycles	0.9 mm
ILSTC25060	10N	Brass	300,000 cycles	0.9 mm
ILSTB18010	4N	Brass	1,000,000 cycles	0.9 mm
ILSTB25030	4N	Brass	1,000,000 cycles	0.75 mm
ILSTB18050	6N	Brass	500,000 cycles	0.75 mm



**NANOT SERIES**  
**Nano Size Tact Switches for SMT**

**Features / Benefits**

SMT and PIP versions  
 2.1 x 1.65 x 0.55 mm & 2.2 x 1.7 x 1.65 mm form factor  
 IP67

**Typical Applications**

Hearing aids  
 Sport & health monitoring watches  
 IoT  
 Headsets

**PART NUMBER**

**Operating Force**

**Contact Material**

**Operating Life**

**Travel**

**NANOT100AS**

100 gf

Copper alloy

200,000 cycles

0.1 mm

**NANOT160AS**

160 gf

Copper alloy

300,000 cycles

0.1 mm

**NANOT240AS**

240 gf

Copper alloy

200,000 cycles

0.1 mm

**NANOT240BP**

240 gf

Copper alloy

200,000 cycles

0.1 mm

**NANOT160BS**

160 gf

Copper alloy

300,000 cycles

0.1 mm

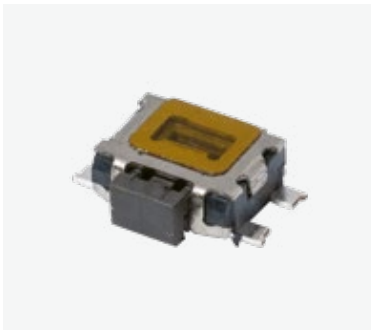

**PTS841 SERIES**  
**Microminiature SMT Side Actuated**

**Features / Benefits**

3.6 x 3.5 form factor  
 Height 1.25 mm  
 IP40

**Typical Applications**

IoT devices  
 Portable devices  
 Remote controls  
 Wearables

**PART NUMBER**

**Operating Force**

**Operating Life**

**Ground**

**Termination Style**

**Pegs**

**PTS841 GM SMTR LFS**

180 gf

100,000 cycles

No

Gull wing

No

**PTS841 GMP SMTR LFS**

180 gf

100,000 cycles

No

Gull wing

Yes

**PTS841 GKP SMTR LFS**

250 gf

100,000 cycles

No

Gull wing

Yes

**PTS841 ESD GK SMTR LFS**

250 gf

100,000 cycles

Yes

Gull wing

No

**PTS841 ESD GMP SMTR LFS**

180 gf

100,000 cycles

Yes

Gull wing

Yes

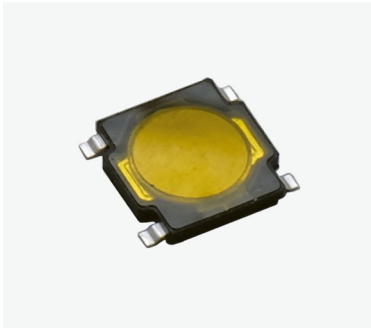

**RK SERIES**

**Microminiature SMT Top Actuated Tact Switches**

**Features / Benefits**

Low profile & microminiature package  
SMT termination  
Hard actuator

**Typical Applications**

Keyfob  
Navigation  
Health monitoring

**PART NUMBER**

**RKA2SGM055SMTR LFS**  
**RKA2SGK055SMTR LFS**  
**RKB2SJK250SMTR LFS**  
**RKB2SJG250SMTR LFS**  
**RKC GG140 SMTR LFS**

**Operating Force**

0.55 mm  
0.55 mm  
2.5 mm  
2.5 mm  
1.4 mm

**Contact Material**

160 gf  
250 gf  
250 gf  
400 gf  
450 gf

**Operating Life**

500,000 cycles  
200,000 cycles  
50,000 cycles  
100,000 cycles  
200,000 cycles

**Travel**

0.2 mm  
0.2 mm  
0.2 mm  
0.2 mm  
0.15 mm



**TLS SERIES**

**Soft Sound Tact Switches**

**Features / Benefits**

Soft sound and long travel  
Soft actuator & pre-travel for an easier tolerance management with possible pre-load  
SMT versions J leads

**Typical Applications**

Automotive interior controls

**PART NUMBER**

**RKA2SGM055SMTR LFS**  
**RKA2SGK055SMTR LFS**  
**RKB2SJK250SMTR LFS**  
**RKB2SJG250SMTR LFS**  
**RKC GG140 SMTR LFS**

**Operating Force**

7N  
10N  
4N  
4N  
6N

**Contact Material**

Brass  
Brass  
Brass  
Brass  
Brass

**Operating Life**

500,000 cycles  
300,000 cycles  
1,000,000 cycles  
1,000,000 cycles  
500,000 cycles

**Travel**

0.9 mm  
0.9 mm  
0.9 mm  
0.75 mm  
0.75 mm

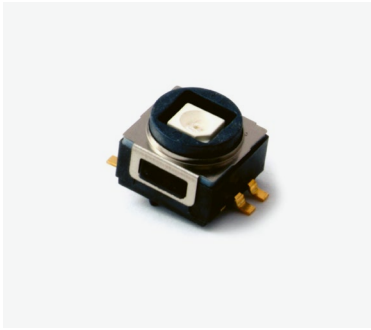

**K5AT SERIES**  
Illuminated Tact Switches

**Features / Benefits**

High bright LEDs  
Reduced space usage on board

**Typical Applications**

Network infrastructure, servers  
Medical

PART NUMBER	Operating Force	Contact Material	LED	Travel	Termination
K5AT WH 43 G	4 N	Gold	White	0.5 mm	SMT
K5AT GA 43 G	4 N	Gold	Green	0.5 mm	SMT



**K8 SERIES**  
Lighted SMT Tact Switches with Rugged LED Mounting Process

**Features / Benefits**

LED qualified for automotive applications  
Various LED options  
No light perturbation  
Sound and haptic  
Various climatic classes

PART NUMBER	Operating Force	Operating Life	Travel
K8xx41G LFS*	4 N	300,000 cycles	0.45 ± 0.15 mm



**K5V SERIES**  
Illuminated Tact Switches

**Features / Benefits**

High bright LEDs  
Reduced space usage on board  
Excellent ergonomics

**Typical Applications**

Network infrastructure, servers  
Automotive  
Medical

PART NUMBER	Operating Force	Contact Material	LED	Travel	Termination
K5V 1 BU 43 T	4 N	Gold	Blue	1.2 mm	PC thru-hole
K5V 1 BA 43 T P3	4 N	Gold	Blue-Amber	1.2 mm	PC thru-hole
K5V 1 YG 43 T	4 N	Gold	Yellow-Green	1.2 mm	PC thru-hole
K5V 5 WH 43 G	4 N	Gold	White	1.2 mm	SMT
K5V 4 BU 43 G P3	4 N	Gold	Blue	1.2 mm	SMT



**KSA / KSJ SERIES**  
**High Performance Sealed Tact Switches**

**Features / Benefits**

Designed for automatic or manual insertion  
 Cambered terminals to ensure self retention  
 Large choice of caps

**Typical Applications**

Automotive  
 Industrial  
 Telecommunication networks

**PART NUMBER**

**KSA0M411 LFTR**  
**KSA0M211 LFTR**  
**KSJ0M41180SH LFTR**

**Operating Force**

3 ± 0.75 N  
 1.4 ± 0.4 N  
 3.3 ± 0.8 N

**Contact Material**

Silver  
 Silver  
 Silver

**Operating Life**

100,000 cycles  
 100,000 cycles  
 100,000 cycles

**Travel**

0.6 ± 0.2 mm  
 0.5 ± 0.2 mm  
 0.55 ± 0.25 mm



**PTS636 SERIES**  
**6.0 x 3.5 Top Actuated**

**Features / Benefits**

6.0 x 3.5 mm footprint  
 Multiple heights  
 THT or SMT type  
 Commercial grade

**Typical Applications**

IoT devices  
 Home automation  
 Remote controls

**PART NUMBER**

**PTS636 SK25 SMTR LFS**  
**PTS636 SM43J SMTR LFS**  
**PTS636 SL50 LFS**

**Total Height**

2.5 mm  
 4.3 mm  
 5.0 mm

**Lead shape**

Gull wing  
 J lead  
 THT

**Operating Force**

250 ± 50 gf  
 180 ± 50 gf  
 130 ± 50 gf

**Operating Life**

100,000 cycles  
 50,000 cycles  
 50,000 cycles

**Travel**

0.25 mm ± 0.1 mm  
 0.30 mm ± 0.1 mm  
 0.30 mm ± 0.1 mm

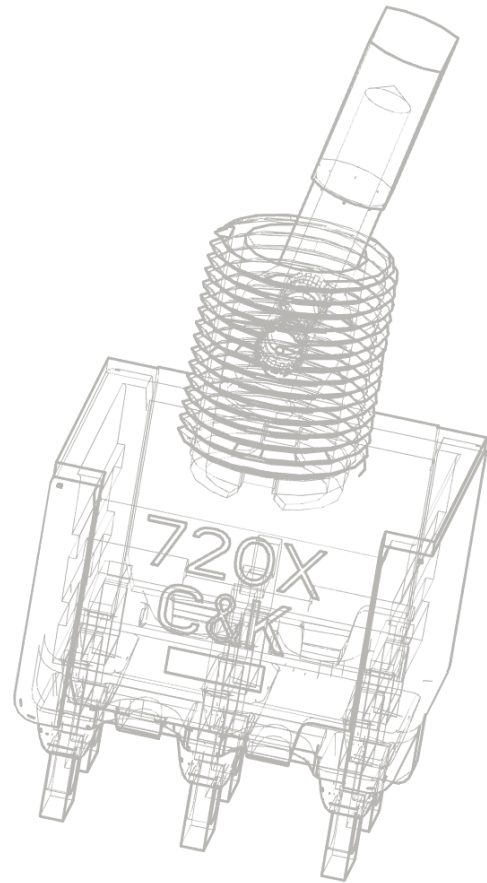
**PRODUCT SELECTION GUIDE**

# Toggle Switches

A toggle switch is an electrical switch that opens and closes an electrical circuit by moving a lever back and forth. C&K's large selection of toggle switches includes low voltage miniature, subminiature, and ultra-miniature models, on up to high power 25A versions. With printed circuit board, SMT and bushing options, C&K toggle switches feature vertical, right angle and vertical right angle mounting brackets.



SERIES	7000	MILITARY	E	ET	T	GT	9000	PT	ILT
<b>Switch Type</b>	Miniature	Miniature	Miniature	Sub-miniature	Sub-miniature	Ultraminiature	Power	Sealed power	Power
<b>Poles / Throws</b>	SPDT / DPDT / 3PDT / 4PDT	SPDT / DPDT	SPDT / DPDT / 3PDT	SPST / SPDT / DPDT	SPST / SPDT / DPDT	SPST / SPDT / DPST / DPDT	DPDT	SPST / SPDT / DPST / DPDT	SPST
<b>Maximum Current: Silver / Gold</b>	5 Amps	5 Amps	7.5 Amps / 5 Amps	3 Amps / 2 Amps	3 Amps / 2 Amps	0.4 VA	10 Amps	25 Amps	20 Amps
<b>Process Sealed</b>			•	•		•		IP68	
<b>PCB Mount Options</b>									
<b>Vertical</b>	•	•	•	•	•	•	•		
<b>Right Angle</b>	•	•	•	•	•	•			
<b>Vertical Right Angle</b>	•	•	•	•	•	•	•		
<b>Surface Mount Options</b>									
<b>Vertical</b>						•			
<b>Right Angle</b>				•		•			
<b>Panel Mount Options</b>									
<b>Rear Mount</b>	•	•	•		•		•	•	•
<b>Terminations</b>									
<b>PCB Thru-hole</b>	•	•	•	•	•	•	•		
<b>Wire Wrap</b>	•		•	•	•				
<b>Solder Lug</b>	•	•	•		•		•	•	
<b>Quick Connect</b>	•		•				•	•	•
<b>Screw Lug</b>								•	
<b>Other Available Options</b>									
<b>Support Brackets</b>	•	•	•	•	•	•	•		
<b>Snap-in Retention</b>	•		•	•					
<b>ESD Protection</b>	•		•	•	•				
<b>Tape &amp; Reel</b>				•		•			
<b>Bushing Options</b>									
<b>10-48</b>					•				
<b>1/4-40</b>	•	•	•		•		•		
<b>15/32</b>	•						•	•	
<b>M6P 0.75 (Metric)</b>	•								



### 7000 SERIES Miniature Toggle Switches

#### Features / Benefits

Multi-pole and multi-position  
Wide variety of actuator and termination options  
Epoxy terminal-seal compatible with bottom wash cleaning

#### Contact Rating:

Gold 0.4 VA max. @ 20 V AC or DC max.  
Silver 5 AMPS @ 120 V AC or 28 V DC, 2 AMPS @ 250 V AC AC

#### Typical Applications

Telecommunications  
Instrumentation  
Medical equipment

PART NUMBER	Function	Actuator	Bushing	Mounting Style / Termination	Contact Material	Electrical Life
7101SYZQE	SPDT On-None-On	Round, .420" high	.350" high, threaded keyway	Solder lug	Silver	100,000 cycles
7201SYZQE	DPDT On-None-On	Round, .420" high	.350" high, threaded keyway	Solder lug	Silver	100,000 cycles
7103SYZQE	SPDT On-Off-On	Round, .420" high	.350" high, threaded keyway	Solder lug	Silver	40,000 cycles
7101SYCQE	SPDT On-None-On	Round, .420" high	.350" high, threaded keyway	PC thru-hole	Silver	100,000 cycles
7101P3YZQE	SPDT On-None-On	Flatted, anti-rotation, .450" high	.350" high, threaded keyway	Solder lug	Silver	100,000 cycles



### MILITARY SERIES MIL-S-83731 Toggle Switches

#### Features / Benefits

Qualified to MIL-S-83731  
50 μ inch selective gold contact plating  
Epoxy sealed terminals for process compatibility

#### Typical Applications

Industrial / Process control  
Military / Aerospace  
Commercial aircraft  
Network systems  
Mass transportation

PART NUMBER	Function	Actuator	Bushing	Mounting Style / Termination	Contact Material	Electrical Life
M83731/9-231	SPDT On-None-On	Round, .420" high	.300" high, threaded keyway	Panel mount, Solder lug	Gold over nickel over silver over brass	20,000 cycles
M83731/9-211	SPDT On-Off-On	Round, .420" high	.300" high, threaded keyway	Panel mount, Solder lug	Gold over nickel over silver over brass	20,000 cycles
M83731/9-271	SPDT Mom-Off-Mom	Round, .420" high	.300" high, threaded keyway	Panel mount, Solder lug	Gold over nickel over silver over brass	20,000 cycles
M83731/9-261	SPDT On-None-Mom	Round, .420" high	.300" high, threaded keyway	Panel mount, Solder lug	Gold over nickel over silver over brass	20,000 cycles
M83731/10-231	DPDT On-None-On	Round, .420" high	.300" high, threaded keyway	Panel mount, Solder lug	Gold over nickel over silver over brass	20,000 cycles



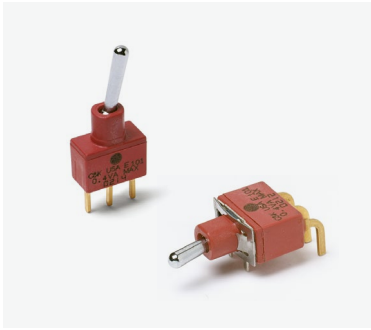

### E SERIES Sealed Miniature Toggle Switches

**Features / Benefits**

Sealed against solder and cleaning process contaminants  
 UL 94V-0 Nylon case and bushing  
 ESD protection available

**Contact Rating:**

Gold 0.4 VA max. @ 20 V AC or DC max  
 Gold over silver 0.4 VA MAX @20 V AC or DC MAX.,  
 7.5 AMPS @125 V AC or 28 V DC, 3 AMPS @ 250 V AC DC  
 Silver 7.5 AMPS @ 125 V AC or 28 V DC, 3 AMPS @ 250 V AC

**Typical Applications**

Telecommunications  
 Instrumentation  
 Medical equipment

PART NUMBERS	Function	Actuator	Bushing	Mounting Style / Termination	Contact Material	Electrical Life
E101MD1ABE	SPDT, On-None-On	.300" high	.250" high, unthreaded	Right angle, PC thru-hole	Gold	40,000 cycles
E105SD1CBE	SPDT, Mom.-Off-Mom.	.500" high	.250" high, unthreaded	PC thru-hole	Gold	40,000 cycles
E101MD1AV2GE	SPDT, On-None-On	.300" high	.250" high, unthreaded	Vertical right angle, PC thru-hole	Gold over silver	40,000 cycles
E101MD1AQE	SPDT, On-None-On	.300" high	.250" high, unthreaded	Right angle, PC thru-hole	Silver	40,000 cycles
E103MD1ABE	SPDT, On-Off-On	.300" high	.250" high, unthreaded	Right angle, PC thru-hole	Gold	40,000 cycles

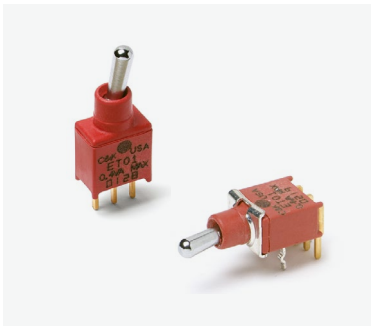

### ET SERIES Sealed Subminiature Toggle Switches

**Features / Benefits**

Sealed against solder and cleaning process contaminants  
 ESD protection available  
 Thru-hole and surface mount models  
 Compact size and small footprint save PCB space

**Contact Rating:**

Gold 0.4 VA MAX. @ 20 V AC or DC MAX.  
 Silver 3 AMPS @ 120 V AC or 28 V DC

**Typical Applications**

Telecommunications  
 Instrumentation  
 Medical equipment

PART NUMBER	Function	Actuator	Bushing	Mounting Style / Termination	Contact Material	Electrical Life
ET01MD1SAPE	SPDT, On-None-On	.240" high	.177" high, unthreaded	Right angle, surface mount	Gold, matte tin	60,000 cycles
ET01MD1CBE	SPDT, On-None-On	.240" high	.177" high, unthreaded	PC thru-hole	Gold	60,000 cycles
ET01MD1ABE	SPDT, On-None-On	.240" high	.177" high, unthreaded	Right angle, PC thru-hole	Gold	60,000 cycles
ET08LD1CBE	SPDT, On-None-Mom.	.320" high	.177" high, unthreaded	PC thru-hole	Gold	30,000 cycles
ET21MD1AQE	DPDT, On-None-On	.240" high	.177" high, unthreaded	Right angle, PC thru-hole	Silver	60,000 cycles

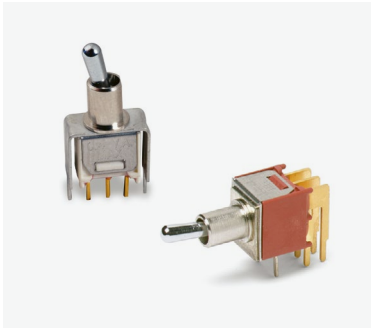

**T SERIES**  
Subminiature Toggle Switches

**Features / Benefits**

Compact size—small footprint  
Single and double pole models  
PC and panel mount options available

**Contact Rating:**

Gold 0.4 VA MAX. @ 20 V AC or DC MAX.  
Silver options up to 3 AMPS @ 120 V AC or 28 V DC

**Typical Applications**

Telecommunications  
Instrumentation  
Medical equipment

PART NUMBER	Function	Actuator	Bushing	Mounting Style / Termination	Contact Material	Electrical Life
T102SHZQE	SPDT Off-None-On	.370" high	.220" high, threaded, flat	Solder lug	Silver	30,000 cycles
T101MH9ABE	SPDT On-None-On	.210" high	.220" high, unthreaded, flat	Right angle, PC thru-hole	Gold	60,000 cycles
T105LH9ABE	SPDT Mom.-Off-Mom.	.290" high	.220" high, unthreaded, flat	Right angle, PC thru-hole	Gold	30,000 cycles
T101MH9AVBE	SPDT On-None-On	.210" high	.220" high, unthreaded, flat	Vertical right angle, PC thru-hole	Gold	60,000 cycles
T211MH9V3BE	DPDT On-On-On	.210" high	.220" high, unthreaded, flat	Vertical mount V-bracket	Gold	30,000 cycles



**GT SERIES**  
Sealed Subminiature Toggle Switches

**Features / Benefits**

Sealed against solder and cleaning process contaminants  
Ultraminiature size, smallest footprint available  
Thru-hole and surface mount models  
High temperature materials (UL 94V-0)  
Contact material gold over nickel

**Typical Applications**

Telecommunications  
Small instrumentation

PART NUMBER	Function	Mounting Style / Termination	Actuation	Contact Rating	Electrical Life
GT11MSABETR	SPDT, On-None-On	Right angle, surface mount	Horizontal	0.4 VA max. @ 20 V AC or DC max.	40,000 cycles
GT11MCBE	SPDT, On-None-On	PC thru-hole		0.4 VA max. @ 20 V AC or DC max.	40,000 cycles
GT23MAVBE	DPDT, On-Off-On	Right angle, PC thru-hole	Vertical	0.4 VA max. @ 20 V AC or DC max.	40,000 cycles
GT11MSCBETR	SPDT, On-None-On	Surface mount	Horizontal	0.4 VA max. @ 20 V AC or DC max.	40,000 cycles



**9000 SERIES**  
**Power Toggle Switches**

**Features / Benefits**

Power ratings up to 10 AMPS  
Locking lever options available  
Wide variety of actuator styles

**Typical Applications**

Shut-off switch  
Small equipment  
Industrial/ Process control  
Professional instrumentation  
Network systems

PART NUMBER	Function	Actuator	Bushing	Mounting Style / Termination	Contact Material	Electrical Life
9221K1Z4QD	DPDT On-On	Locking lever, .680" high	.312" high, threaded keyway	Panel mount, Quick connect terminals	Silver	25,000 cycles
9221SH3Z4QD	DPDT On-On	Round, .410" high	.296" high, flat	Panel mount, Quick connect terminals	Silver	25,000 cycles
9201KAV2QE	DPDT On-On	Locking lever, .650" high	.312" high, threaded keyway	PCB mount, Vert. right angle, PC thru-hole	Silver	25,000 cycles
9201KZQE	DPDT On-On	Locking lever, .650" high	.312" high, threaded keyway	Panel mount, Solder lug	Silver	25,000 cycles



**PT SERIES**  
**Sealed Power Toggle Switches**

**Features / Benefits**

IP66 / IP68 versatile rating to withstand harsh outdoor environments, intense, wet weather, wind blown rain, dust, dirt  
UL 61058-1 certified has global acceptance with no additional testing needed  
Integrated panel seal for extra protection  
Superior oil and fuel resistance  
High strength, heat resistant housing designed for demanding applications subjected to vibration and harsh conditions

**Typical Applications**

Off-road, construction / agricultural vehicles  
Material handling equipment  
Articulating, scissor and bucket lift controls  
Outdoor industrial equipment  
Lift gate controls

PART NUMBER	Function	Actuator	Mounting Style / Termination	Contact Material	Electrical Life
PT101SSQ	SP, On-None-On	Standard	Screw terminal	Silver	10,000 cycles
PT103SQQ	SP, On-Off-On	Standard	Quick connect .250"	Silver	10,000 cycles
PT201SZQ	DP, On-None-On	Standard	Solder terminal	Silver	10,000 cycles
PT202SSQ	DP, On-None-Off	Standard	Screw terminal	Silver	10,000 cycles
PT208SSQ	DP, On-None-Mom	Standard	Screw terminal	Silver	10,000 cycles



**ILT SERIES**  
Illuminated Toggle Switches

**Features / Benefits**

LED built in to toggle handle  
6 LED color options to choose from  
Electrical ratings up to 20 Amps

**Typical Applications**

Instrumentation  
Medical equipment  
Detection  
Control panels  
Heavy equipment

PART NUMBER	Function	Actuator	Bushing	Mounting Style / Termination	Contact Material	Electrical Life
ILT01	On-Off	Illuminated	12.2	Panel / Quick connect	Silver	10,000 cycles
ILT02	On-Off	Illuminated	12.2	Panel / Quick connect	Silver	10,000 cycles
ILT03	On-Off	Illuminated	12.2	Panel / Quick connect	Silver	10,000 cycles
ILT04	On-Off	Illuminated	12.2	Panel / Quick connect	Silver	10,000 cycles
ILT05	On-Off	Illuminated	12.2	Panel / Quick connect	Silver	10,000 cycles
ILT06	On-Off	Illuminated	12.2	Panel / Quick connect	Silver	10,000 cycles

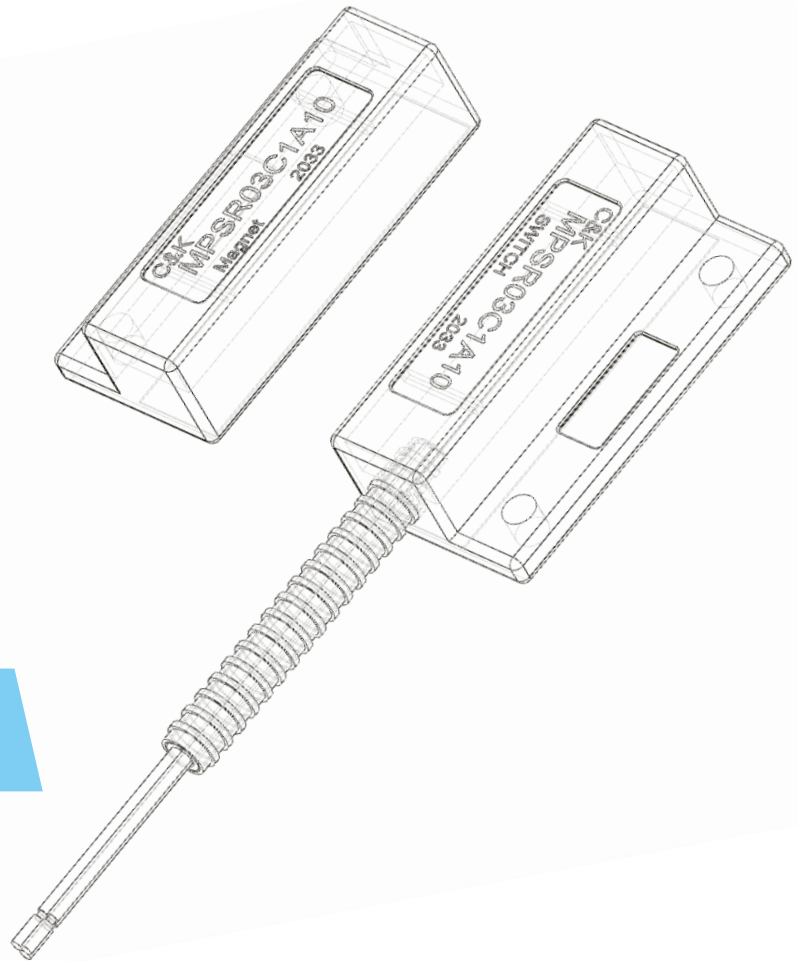

## PRODUCT SELECTION GUIDE

# SENSOR PRODUCTS

C&K's proud history of product innovation continues with sensor solutions ideal for position and proximity sensing in a wide range of applications. Inherently robust with available IP ratings up to IP69, they are capable of millions of operations using magnetic actuation to provide contactless detection across hermetic barriers and distances up to 1". They're designed to be easy to install and easily customizable to fit the needs of applications ranging from automotive and industrial to construction, security and anti-tampering, and medical devices.



**SERIES**

**Actuation**

**Max Actuation Distance**

**Life Cycle**

**Contact Type**

**Max. Voltage**

**Max. Switching Current**

**Housing**

**IP Rating**

**Mounting**

**Wiring**

**Standard Wire Lead Length**

**MPS**

Magnetic

1"

4,000,000

SPST N.O.

30 V

300 mA

Plastic

Surface mount (adhesive or flange)

Insulated wire lead

12"

**MPSR**

Magnetic

1"

4,000,000

SPDT N.O. / N.C.

30V

200 mA

Die-cast aluminum

IP69

Surface mount flange

Stainless steel hoses insulated wire lead

72"



**MPS SERIES**  
**Magnetic Proximity Sensors**

**Features / Benefits**

- Long life - 4M operations
- Sealed contacts
- Quality construction
- UL61058
- Quick & easy installation

**Typical Applications**

- 3.0 W max. @ 30 V DC or 30 V AC max. @ 0.3 AMP max
- 1.0 msec. max. operate time (including bounce)
- 1.0 AMP max. carry current

**PART NUMBER**

**MPS45WGW**

\* Contact C&K for custom options availability

**Function**

SPST N.O. subminiature surface mount (adhesive or flange), side exit leads, 1" make gap



**MPSR SERIES**  
**Ruggedized Magnetic Proximity Sensors**

**Features / Benefits**

- Long life - 4M+ operations
- Hermetically sealed contacts
- Form C (SPDT) contacts w/ 3 W rating
- IP69 Rating
- UL61058
- Quick & easy installation

**Typical Applications**

- Remote monitoring
- Anti-tamper detection
- Security

**Contact Rating:**

200 mA @ 3 W, 30 VDC

**PART NUMBER**

**MPSR03C1A10**

\* Contact C&K for custom options availability

**Function**

Form C (SPDT N.O. / N.C.) 3 W / 30 VDC 72" Stainless steel hose w/ bare wire leads

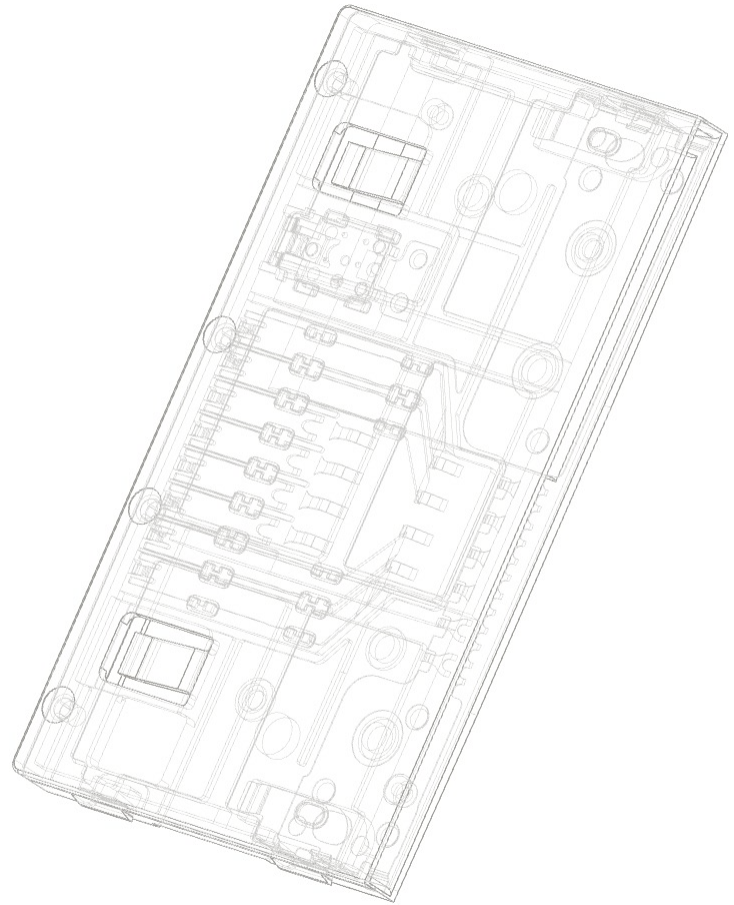
**PRODUCT SELECTION GUIDE**

# Smart Card Connectors

C&K's smart card connectors are EMV and PCI compliant, and offer full-size card acceptance as well as SIM/SAM cards. All smart card connectors are compatible with lead free SMT reflow soldering processes. Full-size smart card connectors feature up to 500,000 cycles lifetime, while SIM/SAM models range from 30,000 to 50,000 cycles.





**CCM01 SERIES**  
**Full Size Card Connectors**

**Features / Benefits**

Operating life up to 500,000 cycles  
Up to 40 N card insertion force  
EMV  
Card detection sealed switch

**Typical Applications**

Transaction  
Identification  
POS

PART NUMBER	Number of Contacts	Termination	Operating Life	Card Insertion Force
CCM01-2327 LFT	8	SMT	600,000 cycles	40 N



**CCM01 MK5 SERIES**  
**Full Size Card Connectors**

**Features / Benefits**

Operating life 500,000 cycles  
Low profile 4 mm and 3.2 mm height  
Card detection sealed switch

**Typical Applications**

Transaction  
Identification  
POS  
MPOS

PART NUMBER	Cover	Number of Contacts	Termination	Operating life
CCM01-2563 LFT	Plastic	8	SMT	500,000 cycles
CCM01-2565 LFT	Plastic	8	SMT	500,000 cycles
CCM01-2663 LFT	Metal	8	SMT	500,000 cycles
CCM01-2664 LFT	Metal	8	SMT	500,000 cycles



**CCM03 SERIES**  
**SIM / SAM Card Connectors**

**Features / Benefits**

SIM / SAM card acceptance  
Hinged and fixed covers  
Compatible with pick and place and lead free soldering  
6 or 8 contacts

PART NUMBER	Number of Contacts	Termination	Contact Plating	Cover	Card Presence Switch	Operating Life
CCM03-3003 LFT	8	SMT	Inlay	Hinged	Without	10,000 cycles
CCM03-3009 LFT	6	SMT	Gold	Hinged	Without	10,000 cycles
CCM03-3013 LFT	6	SMT	Gold	Hinged	With	10,000 cycles
CCM03-3754 LFT	6	SMT	Inlay	Fixed	With	10,000 cycles

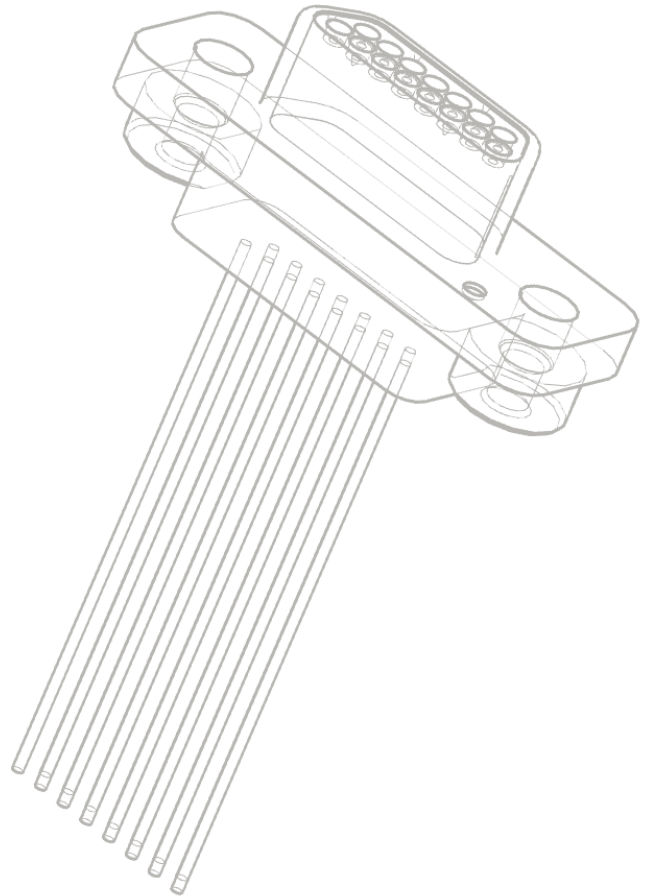

## PRODUCT SELECTION GUIDE

# High Reliability Connectors

C&K's connectors are extremely reliable and high-performing, helping customers design the next generation of military, industrial, aerospace and space applications. The connectors are also highly configurable and available in a variety of sizes and formats. They can handle the harshest of environments, making them perfect for satellites, payload harnesses and launchers.



### D-SUBMINIATURE CONNECTORS

C&K's full line of D\*M and D\*MA Series D-subminiature connectors are employed in satellites and launchers, and meet strict tests for outgassing and residual magnetism. Offered in a variety of contact layouts (including with coax, power or crimp contacts) and shell sizes, the D-sub connectors are available with non-removable and removable contacts, as well as in filtered, pin and socket, and interface configurations.



### MICRO-D CONNECTORS

C&K's full line of MDM Series microminiature connectors are frequently employed to connect various modules within satellite systems. The MDM connectors utilize a proven Micropin™ contact system and are offered in a variety of contact layouts. To date, C&K is the only company that offers ESA-qualified rectangular micro-d microminiature connectors.



### RECTANGULAR MICROMINIATURE CONNECTORS WITH REMOVABLE CONTACTS

Employed in various space equipment applications, C&K's MDMA rectangular microminiature feature removable crimp contacts compliant with ESA/ESCC specifications, along with the highly reliable Micropin™ twist pin contact system. The MDMA connectors are guaranteed to meet 'zero defect' criteria.



### SINGLE IN-LINE MICROMINIATURE CONNECTORS

Utilized in satellites as a connection between PCBs, C&K's MTB1 micro-strip single in-line microminiature connectors also employ a high performance Micropin™ contact system and meet stringent requirements for outgassing and residual magnetism. The connectors are suitable for board-to-board, board-to-cable, and cable-to-cable applications. To date, C&K is the only company that offers ESA-qualified micro-strip single in-line microminiature connectors.



### SPACE SPLICE CONTACTS

A compact, easy-to-use alternative to manual splicing, the one-way Space Splice high-reliability connectors deliver high radiation and temperature resistance, low residual magnetism, and low degassing, and — manufactured in accordance with ESA/ESCC specifications — meet the highest quality requirements for satellite, payload, and other harsh environment applications, including: laboratory, avionics, military, and medical equipment. An EPPL2 (ESA/ESCC European Preferred Part List Part 2) product, the series accepts the most popular cable gauges (AWG 20 – AWG 30) and employs removable, D\*MA crimpable contact technology that allows for both manual and guiding-tool-assisted insertion.



### INTERPOSER CONNECTORS

"Board-to-board" interconnect solderless solution specifically designed for the aerospace industry. Interposer uses C&K's proven Starclip contact technology - the electrical contact function is decoupled from the pressure applied by the spring, which therefore enables the connector to provide a stable, low-contact resistance, regardless of the force applied or distance moved. The interconnects are non-outgassing, with gold-plated contacts, and have an operating temperature range of -55°C to +125°C. They are compliant with CS FR051 C&K specification, according to ESA/ESCC code 3401.

PART NUMBER	PAGE NUMBER	PART NUMBER	PAGE NUMBER
1101M2S3CQE2	51	D101J12S215PQA	41
1101M2S3AV2QE2	51	D501J12S2AHQA	41
1101M2S3AQE2	51	D502J12S2AHQA	41
1201M2S1CQE2	51	D6C90 F1 LFS	24
7101J1ABE2	40	D6L90 F1 LFS	24
7101J1AQE2	40	D6R10 F1 LFS	24
7101J1AV2QE2	40	D6R90 F1 LFS	24
7101P3YZQE	88	D6RLRD F1 LFS	24
7101SYCQE	88	D6RLWH F1 LFS	24
7101SYZQE	88	DF62J12S215PQA	41
7103SYZQE	88	DF62J12S2AHQA	41
7201SYZQE	88	DF62J12S2APQA	41
8121J81ZGE22	33	DS1D6AQ1	62
8121SHZGE	33	DS2D6BQ1	62
8125SHZBE	33	DS2D6CQ1	62
8125SHCBE	33	E101J1AQE2	40
8221SHZGE	33	E101J3V31QE2	40
9201KZQE	91	E101MD1ABE	89
9201KAV2QE	91	E101MD1AQE	89
9221K1Z4QD	91	E101MD1AV2GE	89
9221SH3Z4QD	91	E103MD1ABE	89
A10305RNCB	45	E105SD1CBE	89
A11405RNZQ	45	E201J1V31QE2	40
A20605RNCQK	45	ENCOS16DS5C	46
ADPDC2T04AC	62	EP11SD1ABE	32
AP2D200TWBE	35	EP11SD1AVBE	32
AP2D300SZBE	35	EP11SD1CBE	32
AP4D200TZBE	35	EP11SD1SAPE	32
AP4E300TZBE	35	EP12SD1ABE	32
APB4E01TZBE-001	35	ET01MD1ABE	89
APB4E01TZBE-002	35	ET01MD1CBE	89
ASKHC2J04AC	62	ET01MD1SAPE	89
ASKHC2T04AC	62	ET08LD1CBE	89
ATP16-DL1-000-B4SA-04G	37	ET21MD1AQE	89
ATP16-DL5-606-B3SA-04G	37	FDS001R	9
ATP19-SL1-324-B0SE-03Q	37	FDS002R	9
ATP16-SL1-612-M4SA-04G	37	FDSE001R	9
ATP19-SL3-624-B0DA-03Q	37	FDSE002R	9
ATP19-SL4-612-M0DE-03Q	37	FP11SPA1B1TP02	33
ATP22-SL3-312-B0SA-03Q	37	FP11SPA1B1TP03	33
ATP22-SL3-724-B0SE-03Q	37	FP11SPC1B1TP00	33
ATS2D1GNC LFS	10	FP11SPC1B1TP02	33
ATS2D3GNC LFS	10	FP11SPC1B1TP03	33
AYZ0102AGRLC	52	GT11MCBE	90
AYZ0202AGRLC	52	GT11MSABETR	90
AYZ0203AGRLC	52	GT11MSCBETR	90
BPA01B	18	GT23MAVBE	90
BPA04B	18	H1011U2F205NQ	65
BPA05SB	18	H200AA2F205NQ	65
CCM01-2327 LFT	97	H201132F205NQ	65
CCM01-2563 LFT	97	HDP001R	8
CCM01-2565 LFT	97	HDS001R	8
CCM01-2663 LFT	97	HDT0001	8
CCM01-2664 LFT	97	ILSTB18010	81
CCM03-3003 LFT	97	ILSTB18050	81
CCM03-3009 LFT	97	ILSTB25030	81
CCM03-3013 LFT	97	ILSTC18060	81
CCM03-3754 LFT	97	ILSTC25060	81
CD10RM0SBR	19	ILT01	92
CD16RM0SBR	19	ILT02	92
CRD10RM0CB	19	ILT03	92
CRD16CM0SBR	19	ILT04	92
CRE16RRDL0C	20	ILT05	92
CRE16RRDM0S	20	ILT06	92
CS41001E	28		

PART NUMBER	PAGE NUMBER	PART NUMBER	PAGE NUMBER
ITS10FV1ST	81	KSC441V2SPD LFS	75
ITS13FV2SR	81	KSC461J 70SH LFS PF	77
ITS23FR1ST	81	KSC4D2J50SH LFS	11
ITS40FR2ST	81	KSC4D3J50SH LFG	11
ITS50FV3SR	81	KSC4D3J50SH LFG ULC	11
JS102011JAQN	50	KSC641J LFS	76
JS102011SAQN	50	KSC841J OL LFS	76
JS207011SCQNR	50	KSC941J LFS	76
K12A BK 1 5N	23	KSEK43G LFS	76
K12C 1 5N	24	KSEM31J LFS	76
K12C 1.3 9N 0.5	24	KSJ0MD3860SH LFTR	11
K12GO BK 1.5 6/12N	23	KSJ0VD1860SH LFTR	11
K12P BK 1 5N	23	KSR221G LFS	74
K12P BK 1.5 1.5 OD	13	KSR221G NC LFS	74
K12P BK 2 1.5 OD	13	KSR223G NC LFG	74
K12PL GN 1.5 5N LV306	23	KSR231G LFS	74
K12PL WH 1.5 5N LV302	23	KSR251G LFS	74
K12SA S 1.5 3N C LFTX	12	KSS221G LFS	75
K12SA S 1.5 3N O LFTX	12	KSS231G LFS	75
K12SB D 1.5 3N CC LFTX	12	KSS241G LFS	75
K12SB D 1.5 3N OO LFTX	12	KSU211WFLG	10
K12SB S 1.5 3.5N C LFTX	23	KSU213WFLG	10
K12SB S 1.5 9N O LFTX	23	KT11 B0 SA3M 34 LFS	79
K12SC D 1.5 4/8N OO LFTX	23	KT11 B2 SAM 34 LFS	79
K12SC L 1.5 WHO 9N O LFTX	23	KT11 P3 SA1M 34 LFS73	79
K5AT GA 43 G	84	KT11 P3 SM 34 LFS	79
K5AT WH 43 G	84	KT11 P4 SA2M 35 LFG	79
K5V 1 BA 43 T P3	84	KXT 311 LHS	71
K5V 1 BU 43 T	84	KXT 321 LHS	71
K5V 1 YG 43 T	84	KXT 331 LHS	71
K5V 4 BU 43 G P3	84	L103111MS02Q	52
K5V 5 WH 43 G	84	L20202MA04Q	52
K8xx41G LFS	84	L203111MS02Q	52
KMR211G LFS	71	L212132MV02QE	52
KMR401G LFS	12	LCGGL9P00EC	60
KMR621NG LFS	71	LCGHF5A10RCE	60
KMR73N1G LFS	71	LCS011T05QDC	60
KMS221G LFS	72	LCS051P00PDC	60
KMS231G LFS	72	LCS051P00SDC	60
KMT011NGJ LHS	71	M83731/9-211	88
KMT031NGJ LHS	71	M83731/9-231	88
KMT071NGJ LHS	71	M83731/9-261	88
KMT0D1 NGJ LHS	12	M83731/9-271	88
KMT0D3 NGJ LHG	12	M83731/10-231	88
KS11 R2 2 C Q D	25	MPS45WGW	95
KS12 R2 1 C B D	25	MPSR03C1A10	95
KS12 R2 3 C B E	25	MS-105A01 (H)	58
KSA0M211 LFTR	85	MS-118305-G	58
KSA0M411 LFTR	85	MS-118405-H	58
KSC SLT 221G LFS	78	NANOT100AS	82
KSC SLT 223J LFS	78	NANOT160AS	82
KSC SLT 241J LFS	78	NANOT160BS	82
KSC2 TE 01J LFS	77	NANOT240AS	82
KSC2 TE 31J LFS	77	NANOT240BP	82
KSC2 TE 41J LFS	77	NP8S2D203QE	36
KSC241J LFS	76	NP8S2D2W4QE	36
KSC321J LFS	76	NP8S2R203QE	36
KSC421G 70SH LFS OF	77	NP8S2T203QE	36
KSC422J 70SH LFS PF	77	NP8S3D203QE	36
KSC441G 70SH LFS PF	77	OS102011MS2QN1	51
KSC441J 70SH LFS	76	OS103011MS8QP1	51
KSC441J 70SH LFS OF	77	OS202011MA0QN1	51
KSC441G DCT 70SH LFS	76	OS202011MS2QS1	51
KSC441J DCT 70SH LFS	76	PCM12SMTR	53
KSC441J ST2 LFS	76	PCM13SMTR	53

PART NUMBER	PAGE NUMBER	PART NUMBER	PAGE NUMBER
PLP16C1RD3SE6	37	RTE0400N04	18
PLP16C1SQ3SA4	37	RTE1002G14	18
PLP16C2TA6SA6	37	RTE1600V44	18
PLP1600RD6SA6	37	RTF16R0C	19
PLP1624RD3DE6	37	RTF16R0S	19
PLP1624SQ3DE6	37	SAM-H2-LR10SPA	28
PLP1624SQ6SE4	37	SAM-H2-LR14SPA	28
PLP1624TA3SA6	37	SAM-H2-MR14SPA	28
PNP8S2D2YW2QE	36	SAM-H4-MR11SPA	28
PNP8S2T2C03GE	36	SDA03H0SBR	17
PNP8S2T2C03QE	36	SDA04H0SBR	17
PNP8S2T2CW3QE	36	SDA08H0B	17
PS-12G01	34	SDS0001	9
PS-12G03	34	SER BK AU OA	25
PS-2214-F NS PA	34	SERU AU OA	25
PS-2214-L NS PA	34	SET BK AU OA	25
PT101SSQ	91	SK-12D04-VG 3 NS	53
PT103SQQ	91	SK-12D07-G 5 NS PA	53
PT201SZQ	91	SK-12D07-VG 4 NS PA	53
PT202SSQ	91	SK-13D21-G 2 RT	53
PT208SSQ	91	SK-14D01-G6	53
PTS125SJM73 SMTR-2 LFS	80	SRK GY	25
PTS125SK43-2 LFS	80	SS-12D07-VG 4 NS GA PA	50
PTS526 SK G 15J SMTR2 LFS	72	SS-12D1505-G 2	50
PTS526 SM 08 SMTR2 LFS	72	SS-14D08-VG 5 PA	50
PTS526 SP 20 SMTR2 LFS	72	SS-22D0205-G 2	50
PTS530GK055SMTRLFS	72	SS-22D07-G 2 NS PA	50
PTS530GM055SMTRLFS	72	SSW 115S	59
PTS540JK035SMTRLFS	73	STK WH	25
PTS540JM035SMTRLFS	73	SW-13A65N-A01	42
PTS636 SK25 SMTR LFS	85	SW-13A65N-A01 BK	42
PTS636 SL50 LFS	85	T101MH9ABE	90
PTS636 SM43J SMTR LFS	85	T101MH9AVBE	90
PTS641SM31SMTR2LFS	79	T102SHZQE	90
PTS641TK25SMTR2LFS	79	T105LH9ABE	90
PTS645SL43SMTR92 LFS	80	T211MH9V3BE	90
PTS645VH58-2 LFS	80	TDA04H0SB1R	17
PTS647SN50SMTR2 LFS	80	TDA08H0SB1R	17
PTS815 SJG 250 SMTR LFS	73	TDA10H0SB1R	17
PTS815 SJK 250 SMTR LFS	73	TFCDK6ST2640C	61
PTS815 SJM 250 SMTR LFS	73	TFCJL3SP004AC	61
PTS820J25KSMTRLFS	73	TF325CFP0040Y	61
PTS820J25MSMTRLFS	73	THB001P	28
PTS840ESDPSMTR LFS	74	TP11SH8ABE	32
PTS840GKPSMTR LFS	74	TP11SH9ABE	32
PTS840GMPMTR LFS	74	TP11SH9CBE	32
PTS840PMSMTR LFS	74	TP11SHZQE	32
PTS841 ESD GK SMTR LFS	82	TP12SH9ABE	32
PTS841 ESD GMP SMTR LFS	82	V80212MA08Q	54
PTS841 GKP SMTR LFS	82	V80212MS02Q	54
PTS841 GM SMTR LFS	82	V80212S205Q	54
PTS841 GMP SMTR LFS	82	Y101132C203NQ	65
PVA1EEH1 3.5N V2	34	Y1011U2C203NQ	65
PVA1OAH1 1.2N V2	34	Y201132C203NQ	65
PVA2EEH3 1.2N V2	34	ZMA00A150L04PC	58
PVA2OAH5 1.7N V2	34	ZMA03A150A03PC	58
R10815RS02Q	45	ZMA03A150S07EC	58
R20407RR03Q	45	ZMW00AP00PCAA	59
R20507RR02Q	45	ZMW00AT10SCAA	59
RB-231X2	13	ZPA00A150P00T	59
RB-441-45	13		
RKA2SGK055SMTR LFS	83		
RKA2SGM055SMTR LFS	83		
RKB2SJK250SMTR LFS	83		
RKB2SJK250SMTR LFS	83		
RKC GG140 SMTR LFS	83		

**Products Only**

C&K Components, Inc. (C&K) warrants its products against defects in manufacturing if the products are used for the purpose for which they were manufactured and sold. C&K will, at its option, repair or replace any of its products with a manufacturing defect. This warranty shall expire one year from the date of shipment. THIS WARRANTY IS IN LIEU OF ALL WARRANTIES, WRITTEN OR ORAL, EXPRESS OR IMPLIED, INCLUDING THE WARRANTIES OF MERCHANTABILITY OR FITNESS FOR A PARTICULAR PURPOSE, ALL OF WHICH ARE HEREBY EXCLUDED. SPECIFICATIONS AND PRODUCT LITERATURE REFERRING TO, ATTACHED TO OR FURNISHED WITH PRODUCTS ARE DESCRIPTIVE ONLY AND SHALL NOT BE TREATED AS WARRANTIES. The purchaser or subsequent owner or user's sole and exclusive right or remedy shall be limited to the furnishing of replacements for products found defective by C&K. No oral waiver or modification of this warranty shall have any effect whatsoever, regardless of by whom such waiver or modification is given.

This warranty is void if any modification is made on the warranted product, regardless of whether the modification causes or contributes to the alleged defect. All modifications are made at the risk of the party making the modification. Purchaser indemnifies and holds harmless from all claims or causes of action arising from modifications made to products which are not under the control of C&K. If purchaser buys and resells the product, purchaser agrees to inform its customers that C&K makes no express or implied warranties because of the modification. C&K's warranty is also void if product failure results from acts or omissions of persons other than C&K, or from accident, acts of nature, abuse, misuse or misapplication of the product.

**Customer Communication**

15 Riverdale Ave. Newton, MA 02458.

For product information, inquiries & quotes, order or contract amendment handling customer feedback, customer complaints: Contact Customer Service 617.969.3700, Fax 617.969.6600, Web Address: [www.ck-components.com](http://www.ck-components.com)

**Terms and Conditions of Sale with Limitations of Remedy and Liability**

1. The warranty provided above, or any warranty duly provided by C&K, shall constitute the sole remedy of purchaser and any subsequent owner or user of the product; and shall be the sole liability of C&K, whether in contract, tort, strict liability, under warranty or otherwise. In no event shall C&K's liability exceed the amount of the purchase price paid to C&K by the purchaser for the allegedly defective product. C&K shall not be liable under any circumstance for special, indirect or circumstantial damages, including loss of profit or production.
2. Purchaser and any subsequent owner of the product shall have no claim against C&K for any labor, downtime or expenses of any kind arising from any C&K default whatsoever, including delay shipment.
3. No agreements of sale or contract shall exist between C&K and purchaser until accepted by C&K. All such agreements shall be deemed to take place in Massachusetts, regardless of the origin or destination of the product.
4. Notwithstanding any term or condition imposed or set forth by purchaser's documents or purchase order, C&K objects and takes exception to any provision therein which conflicts with or is in addition to C&K's Terms and Conditions of Sale with Limitations of Remedy and Liability. C&K's performance of any purchase order is conditional upon the purchaser accepting all C&K's said terms, conditions and limitations. Failure of the purchaser to object to these Terms and Conditions of Sale with Limitations of Remedy and Liability within seven (7) days shall constitute full and final acceptance thereof by purchaser.

5. Purchaser agrees to notify all subsequent owners and users taking through purchaser of these Terms and Conditions of Sale with Limitations of Remedy and Liability and, failing to do so, shall indemnify and hold C&K harmless from all claims or causes of action by such persons which are applicable to said terms, conditions and limitations.

6. No product shall be returned to C&K without its prior permission. No cancellations or reschedules to open orders are permitted within factory lead time. Orders are to be scheduled for delivery within 12 months from order date.

7. Delivery schedules are subject to prior sale and circumstances in effect at the time the purchase order is accepted by C&K. C&K shall not be held responsible for delays in delivery due to strikes; work stoppages; fires; floods; accidents; inability to obtain materials, fuels or transportation; government edict; civil unrest or any other cause unavoidable or beyond the control of C&K. C&K shall not be liable for any damages or costs based upon late delivery including instances where C&K has been informed in advance of the consequences.

8. Unless otherwise agreed by C&K, all payments shall be in U.S. currency in immediate funds. Payment terms, unless otherwise agreed by C&K, shall be as specified on C&K's invoices. All amounts remaining unpaid beyond said terms shall accrue interest at the rate of one and one-half (1-1/2) percent per month or the highest lawful interest rate, whichever is lesser, until paid in full. C&K's prices are exclusive of sales, excise, use, occupation, value-added or any other taxes levied on sales transactions. Purchaser must pay all such applicable taxes unless it provides C&K with a valid, current exemption certificate. C&K shall have no obligation to contest or withhold such taxes on behalf of the purchaser.

9. Unless otherwise specified, all shipments are F.O.B. shipping point. Loading or special packaging charges shall be for the account of purchaser. Title to and possession of the product, including all risk of loss, shall pass to purchaser upon delivery to the carrier at the point of shipment.

10. C&K retains a security interest in all products shipped to secure payment of the purchase price and all other amounts owed by purchaser to C&K. Purchaser agrees to cooperate with C&K in protecting this security interest.

11. Any and all indemnities for the benefit of C&K hereunder shall include attorneys' fees and costs, including third party and expert witness fees. Furthermore, purchaser shall reimburse C&K for its costs and attorneys' fees in collecting any sums owed by purchaser to C&K, or for enforcing these Terms and Conditions of Sale with Limitations of Remedy and Liability.

# LOCAL RESOURCES FOR A GLOBAL MARKET

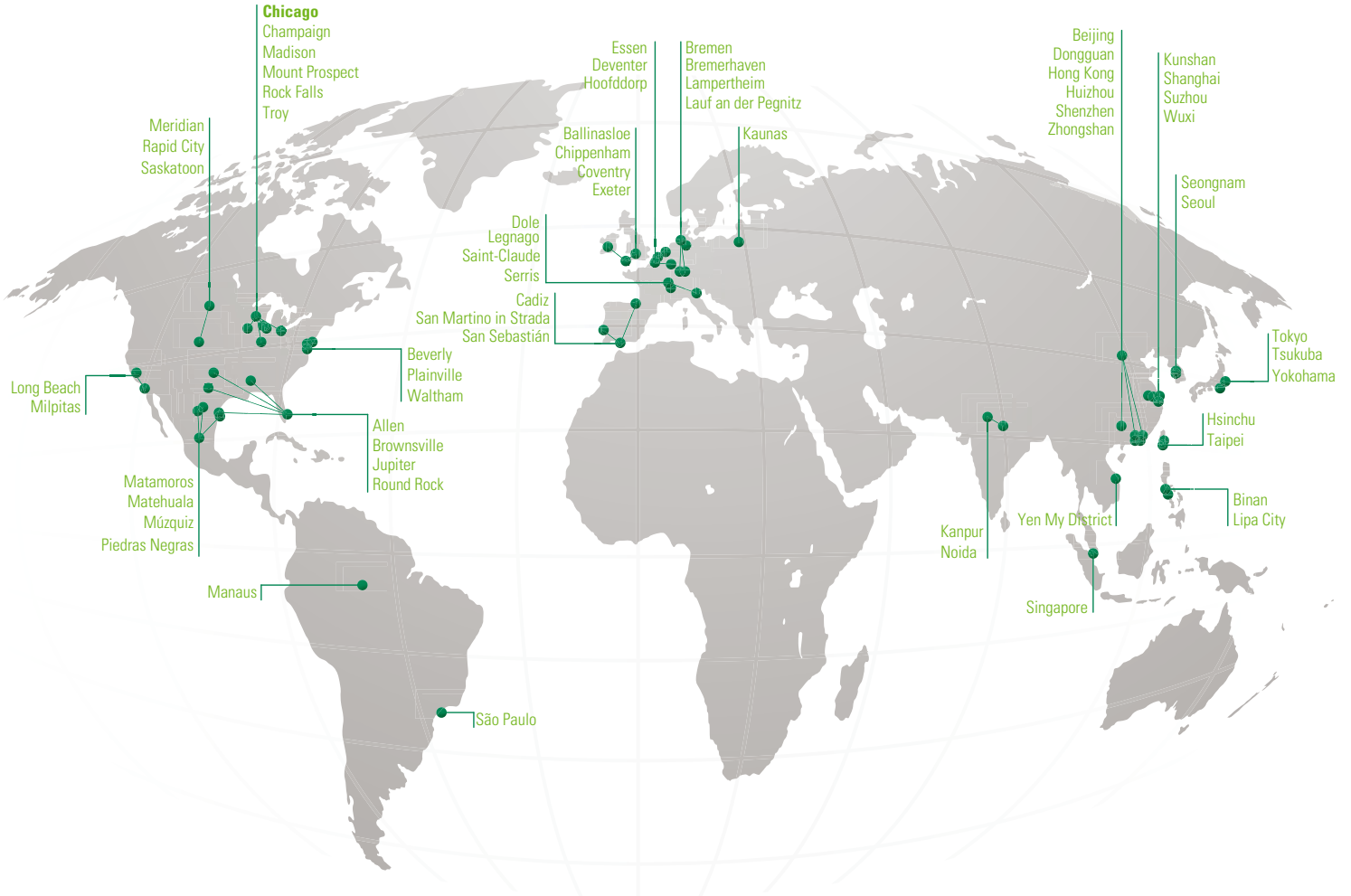

Disclaimer Notice – Information furnished is believed to be accurate and reliable. However, users should independently evaluate the suitability of and test each product selected for their own applications. Littelfuse products are not designed for, and may not be used in, all applications. Read complete Disclaimer Notice at [www.littelfuse.com/product-disclaimer](http://www.littelfuse.com/product-disclaimer).

